

NYMNPA

25/11/2020

From: Christine Maw
Sent: 24 November 2020 19:50
To: Kelsey Blain
Subject: Cross sections

Hi,

Hope these are ok, my joiner has sent these for you. The first ones are for the windows and the last few the doors.

Kind Regards

Christine



TAWINDOWS
we make windows...easy

Trentham stormproof
window sections.
Scale 1:1

jambs & head

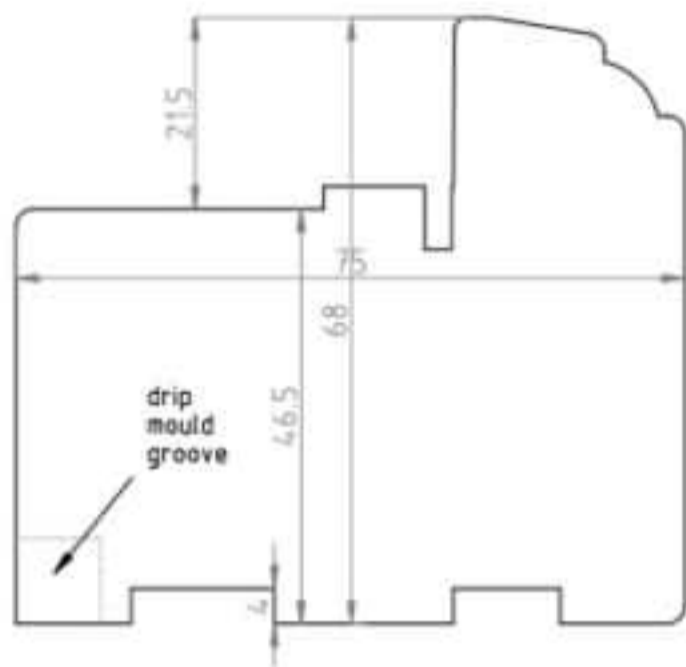

sash



cill

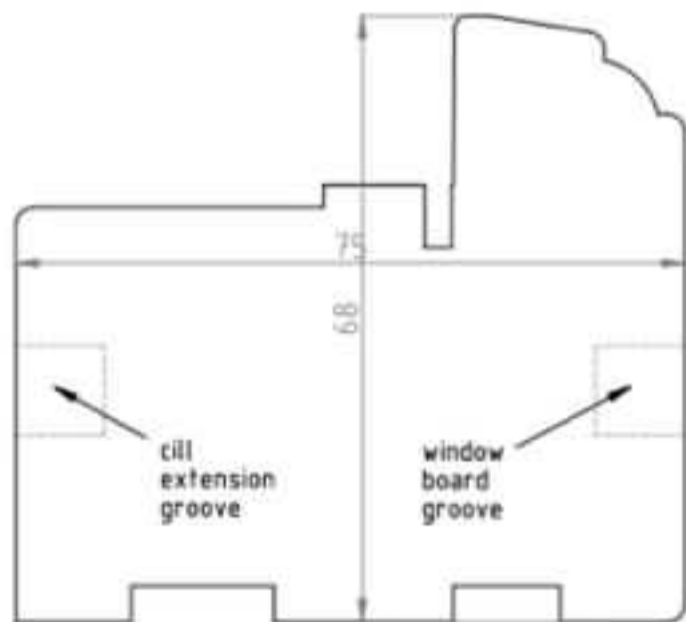

mullion & transom

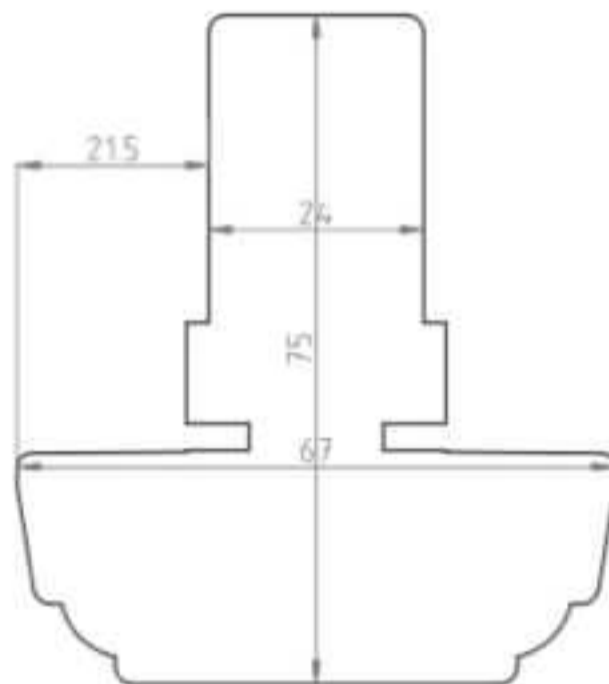

projecting cill

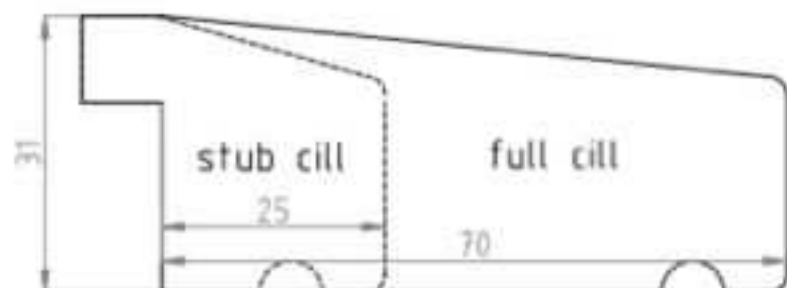

drip

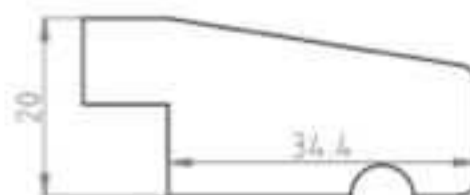

NYMNP A

25/11/2020



Drip Mould

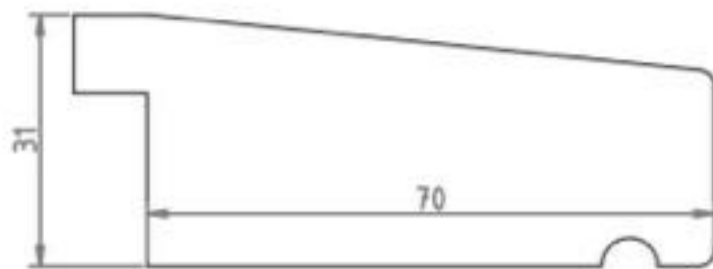

70mm Cill

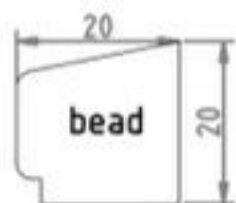

bead

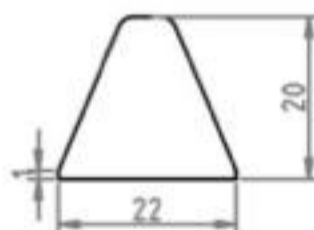

Bonded Bar Inside

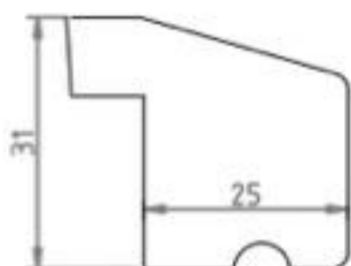

25mm Cill

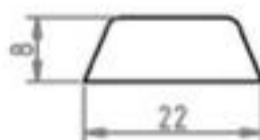

Bonded Bar Outside

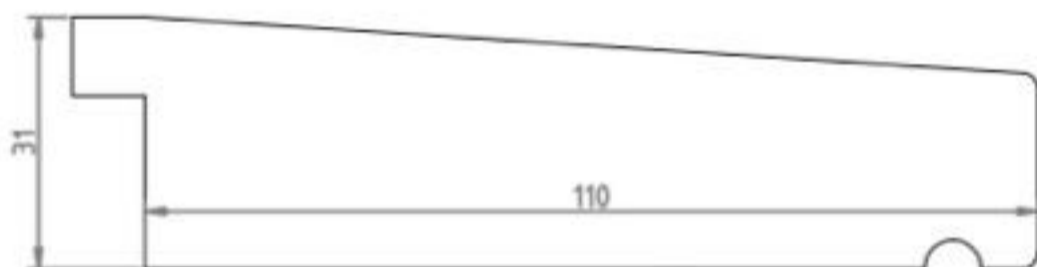

110mm Cill

NYMNP

25/11/2020



Single Glazed Bead



jamb & head

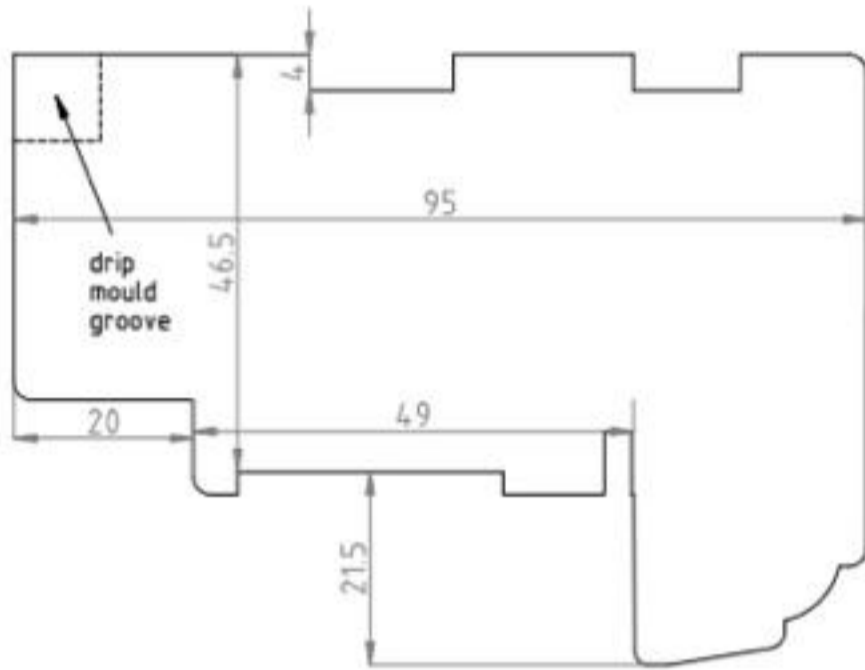

sash

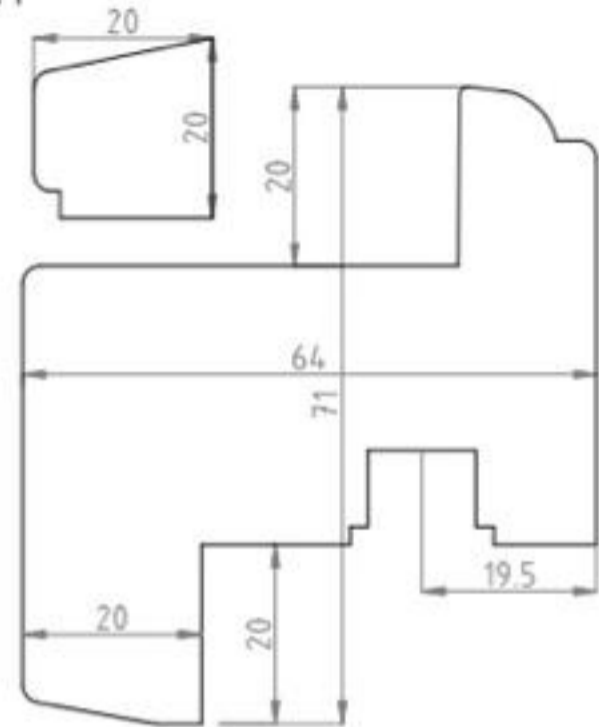

cill

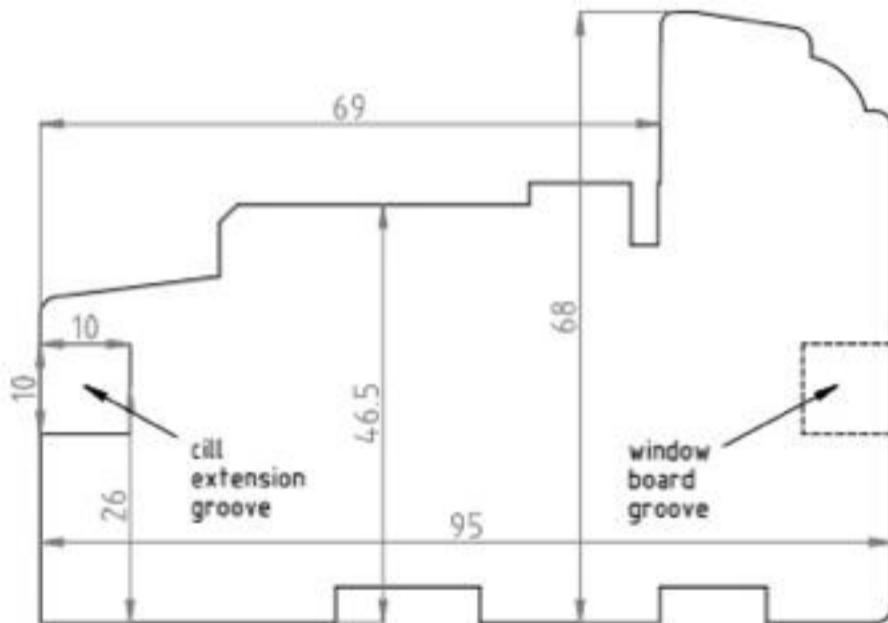

transom

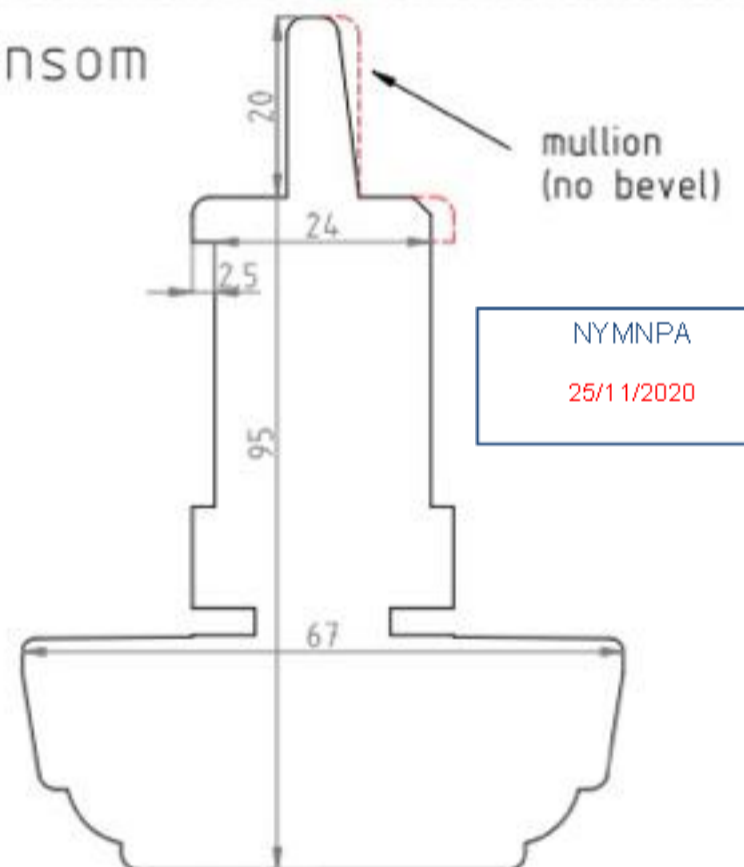

projecting cill

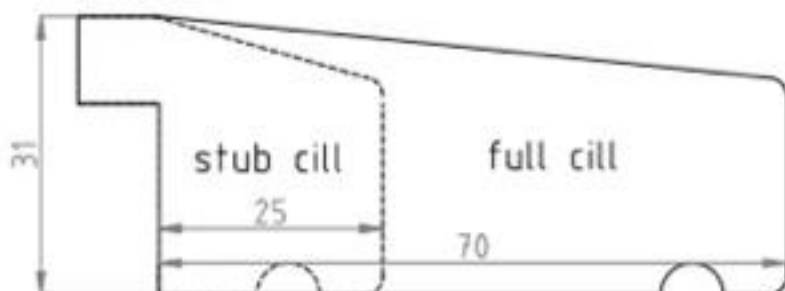

drip

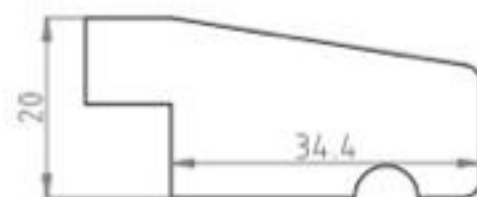

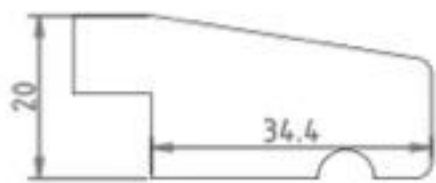

Drip Mould

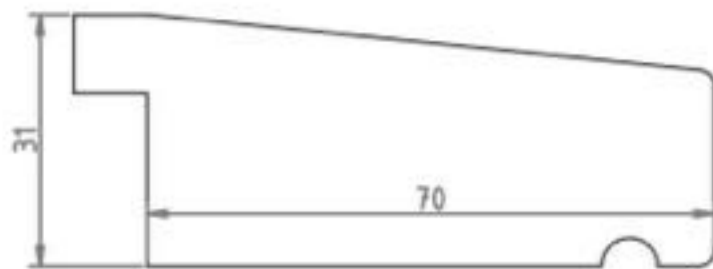

70mm Cill

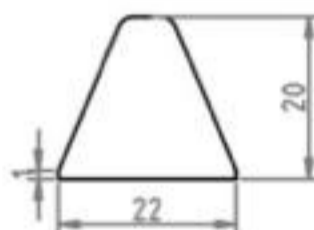
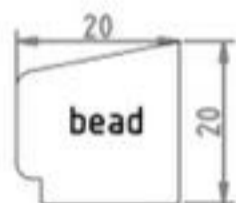

Bonded Bar
Inside

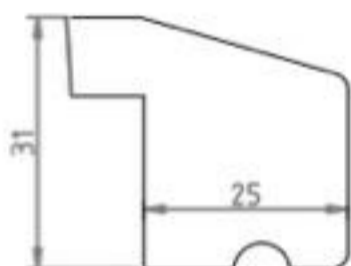

25mm Cill

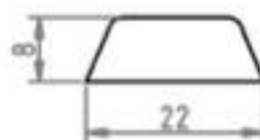

Bonded Bar
Outside

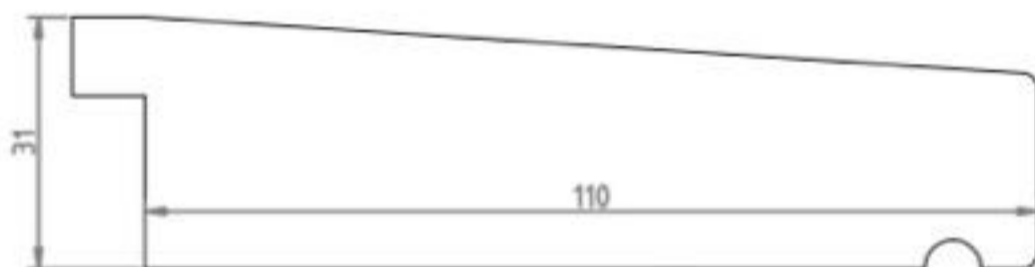

110mm Cill

NYMNPA

25/11/2020



Single Glazed
Bead

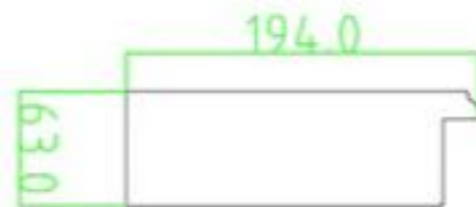
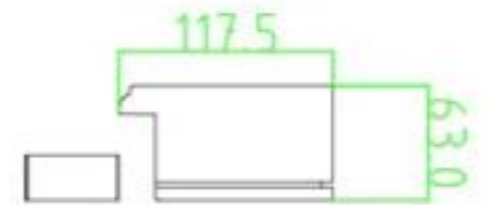
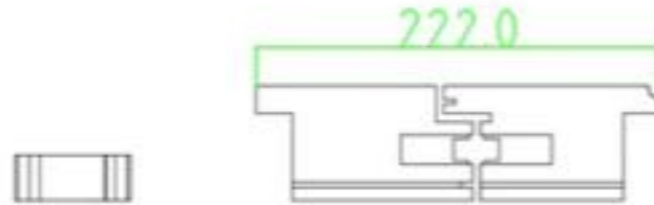
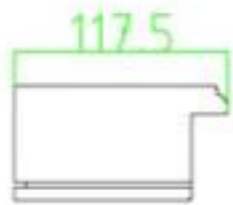
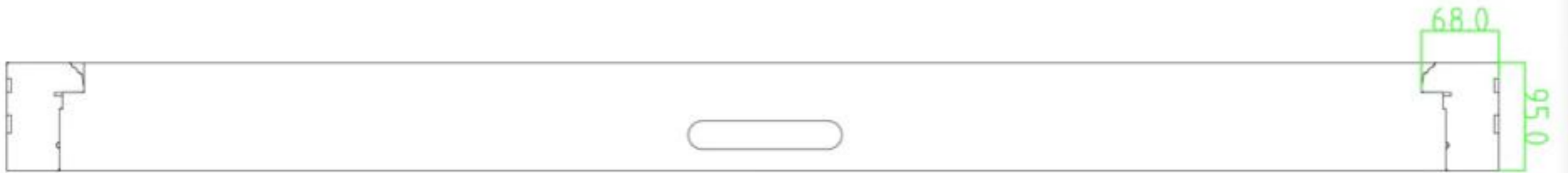

NYMNPA
25/11/2020



TAWINDOWS
we make windows...easy

Staffordshire Door Sections

jambs & head

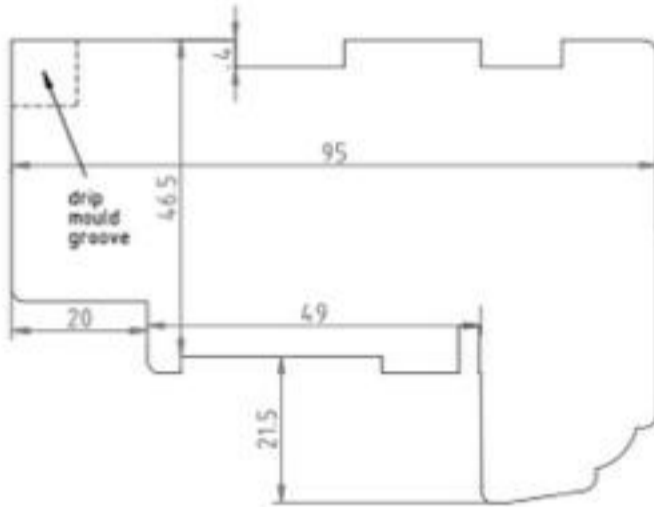

RH Door

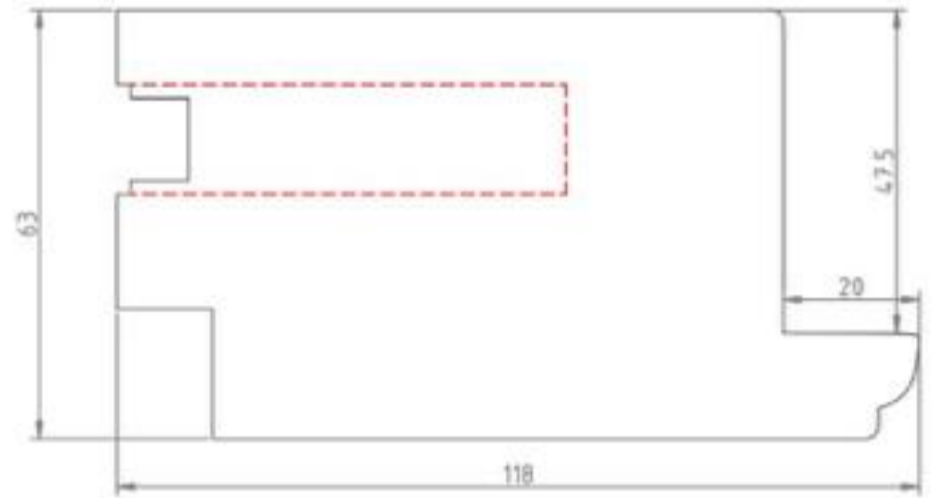

cill

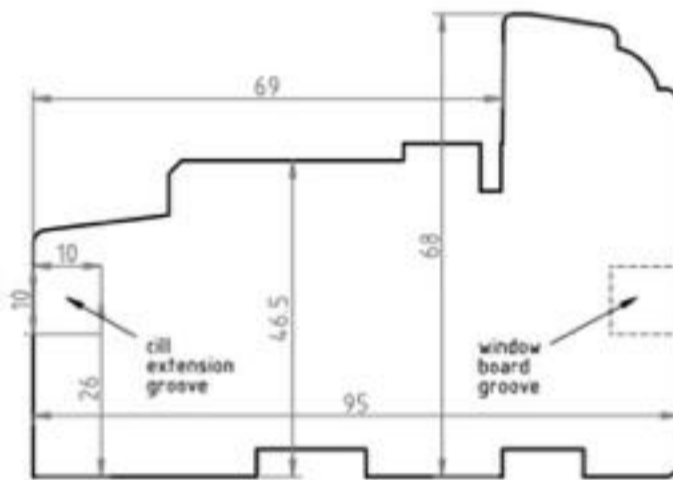

LH Door

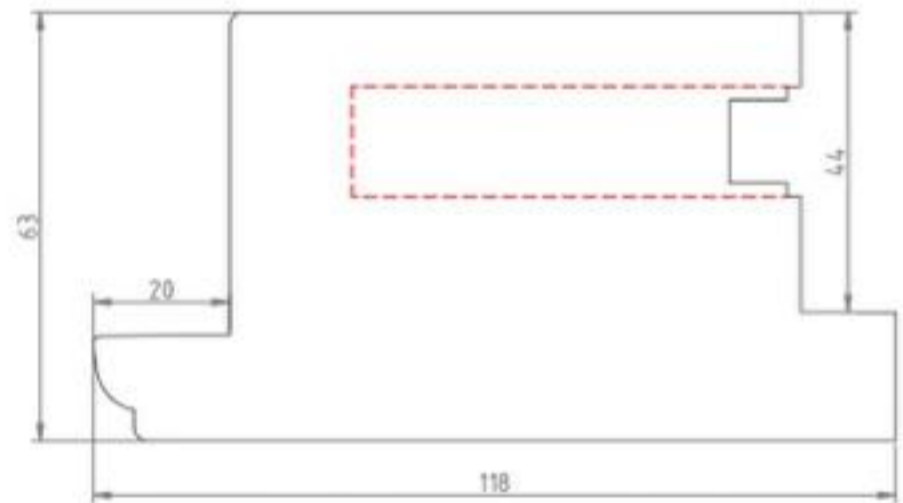

Bead

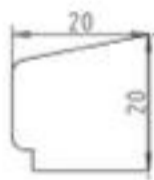

NYMNP A

25/11/2020