

**From:** [LJC Architectural](#)  
**To:** [Planning](#)  
**Subject:** Re: NYM/2024/0470, East End Farm, East End, Egton  
**Date:** 15 July 2024 12:45:25

---

Good afternoon,

Please find the attached link including the details of the roof lights. The roof windows are conservation windows from Keylite - 78 x 118 cm in black.

<https://keylite.it/en/>

Kind regards,  
Hayley Nixon BSc (Hons)  
LJC Architectural Design  
01642 449744



On Mon, 8 Jul 2024 at 11:19, <[planning@northyorkmoors.org.uk](mailto:planning@northyorkmoors.org.uk)> wrote:

Reference: NYM/2024/0470.

Site address: East End Farm, East End, Egton

The North York Moors National Park Authority Planning Service welcomes public engagement in all aspects of its work. You have received this email in relation to a current planning matter. The attached correspondence informs you which officer is dealing with the matter and contains important information which you are advised to retain for your records. If you have any queries, please do not hesitate to contact us. When replying it's best to quote our reference number, which is included in the attached letter.

Kind regards

***Chris France***

Chris France  
Director of Planning  
North York Moors National Park Authority  
The Old Vicarage  
Bondgate  
Helmsley, York YO62 5BP  
Tel: 01439 772700  
[www.northyorkmoors.org.uk](http://www.northyorkmoors.org.uk)



Shop



## Window

Keylite's Conservation Roof Window is designed to complement both renovation & new build projects in a traditional style.

It is ideal for use in a period style property, replicating the look of a traditional skylight.

The black central glazing bar and low profile external flashing maintain the traditional character of the building, whilst still accommodating the flow of natural light to the interior below.

Classic Design – White traditional in its external appearance, the standard Conservation Roof Window benefits from all of the Keylite features including thermal efficiency, low maintenance and ventilation control.

Centre Pivot – Centre Pivot Conservation Windows are available in Pine or White finish.

Thermal Performance – Only Keylite windows have an Expanding Thermal Collar, Warm Edge Glazing and a Streamlined Fit as standard, leading to enhanced thermal performance.

Top Hung – Top Hung/ Fire Escape Conservation roof windows available in pine or white finish.

**NYMNPA**  
**15/07/2024**

Buy

**PROPOSED; DEMOLITION OF SIDE EXTENSIONS,  
CONSTRUCTION OF REPLACEMENT SINGLE STOREY  
SIDE EXTENSIONS TO CREATE ADDITIONAL  
ACCOMMODATION, CONSTRUCTION OF SINGLE  
STOREY REAR EXTENSION WITH FLUE & SITING OF  
SHEPHERDS HUT, POTTING SHED, GREENHOUSE FOR  
DOMESTIC PURPOSES & SITING OF OIL TANK TO SIDE  
OF DWELLING, TOGETHER WITH CREATION OF POND  
(PART RETROSPECTIVE) AT EAST END FARM, EGTON  
WHITBY, YO21 1UF**

**RELEASE OF CONDITIONS ON PLANNING APPLICATION  
REF NYM/2023/0550**

**Introduction**

The following is a list to release the Conditions for the above application.

- 1) The work is to start within the next few months dependant on when the Conditions are released.
- 2) The Proposals hereby permitted shall be carried out in accordance with the drawings

Amended Location Plan	No Number	17/5/2024
Amended Plans & Elevations	Dwg 02 rev H	17/5/2024
Domestic Structures	Dwg 04	2/2/2024
Proposed Pond	Dwg 04	2/2/2024
- 3) Any further building works that deviate from those approved or any further works will require a further planning application.
- 4) I confirm that the Shepherds Hut shall be used for domestic purposes incidental to the purposes incidental to the occupation of the main dwelling on the site and for no other purpose.
- 5) I confirm that the Potting Shed, greenhouse and Chicken Coop

will be used for domestic purposes incidental to the occupation of the main dwelling on the site and used for no other purpose.

- 6) I confirm that all new external materials in the development hereby permitted shall match that of the existing building including the colour and texture and finish and where these include stone and/brick, the method of coursing and pointing in the local tradition.
- 7) Full details are attached to this application ie

**Details of windows.**

Wood Grain effect pvc – Agate Grey  
Sliding sash with no trickle vents or cills.  
2 over 2 with mechanical joints and seamless welds.  
Obtained from the Legacy range from Chatsworth Windows in Northallerton from Spectus Window Systems.  
Colour Agate grey in wood effect pvc  
Deatails attached.

**Details of doors.**

Wood effect pvc/composite. Incldes fames and rain bar.  
Colour – Agate grey.  
Front Door – Fully Planked.  
Rear Door - Fully Planked Stable Door with window in top section.  
Details attached.

- 8) **Rooflights**

Details of the rooflights are as follows: =  
Conservation Grade as shown from Keylite.  
Size 780 x 1180mm  
Colour - Black  
Full details attached.

- 9) I confirm that the windows will not have trickle vents and will remain so in perpetuity.
- 10) I confirm that all rainwater and foul water goods will be coloured black and maintained in that condition in perpetuity.

- 11) I confirm all flues will be coloured matt black and maintained in that condition in perpetuity.
- 12) I confirm that the external surface of the roof of the potting shed and shepherds hut shall be coloured dark grey or black within 6 months of this decision and maintained as such in perpetuity
- 13) I confirm that the external timber cladding and timber structural frame of the potting shed shall be stained dark brown within 6 months of the approval and maintained as such in perpetuity.
- 14) I confirm that the exterior of the shepherds hut shall be painted or stained a dark colour within 6 months of the date of the approval and maintained as such in perpetuity.
- 15) I confirm no first floor or mezzanine will be constructed within the extension.
- 16) I confirm that the pond shall not be used for any commercial purpose, including any sporting activities. No supplementary feeding (ie ducks or gamebirds) shall be carried out within or around the edges of the wildlife pond and there will be no introduction of fish or ducks to the pond in order to ensure that the ecological value of the pond is maximised.
- 17) I confirm that the existing (presently used) access to the property would comply with the requirements as stated in the Condition as stated in the Approval Notice. ie 45m measured along both channel lines of the road from a point measured 2.4m down the centre line of the access road. Eye height is 1.05m. This visibility must be maintained clear of any obstruction and retained for the intended purpose at all times.
- 18) The hedgerows are all being replanted where there are dead areas. Three number bat boxes are fitted where the swallows nest and an owl box is to be fitted to house the resident owl.

Notwithstanding the foregoing the following I would ask that  
Conditions are able to be released if suitably addressed.

## OUTER FRAME

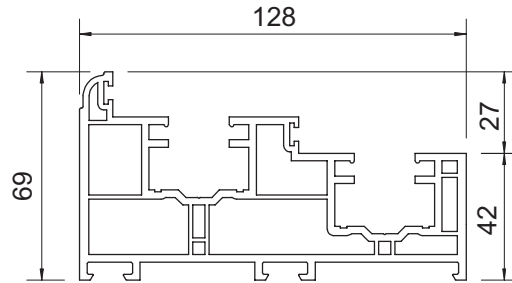

VS01 Outer Frame

## CILLS

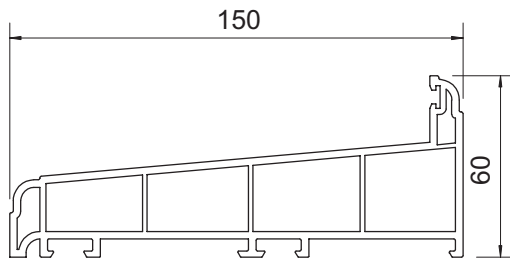

VS02 Cill

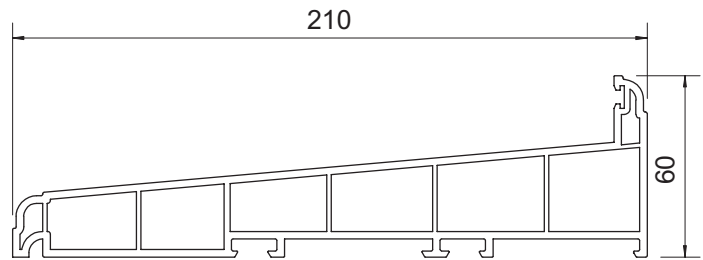

VS14 Extended Cill

## SASHES

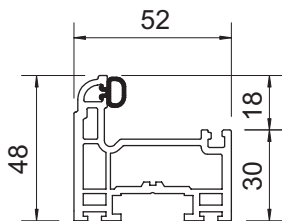

VS03 Small Sash

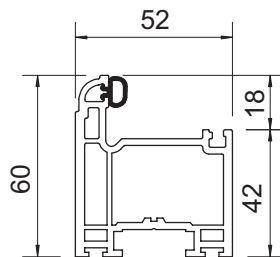

VS04 Standard Sash

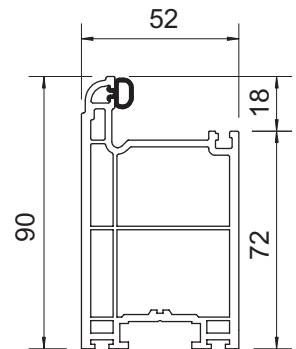

VS05 Deep Bottom Rail

## INTERLOCKS & STOP

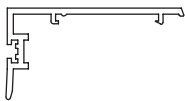

VS09 Interlock

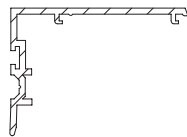

VSR9  
Aluminium Interlock

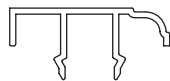

VS10 Sash Stop

## BEADS & ANCILLARIES

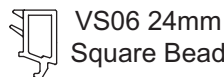

VS06 24mm  
Square Bead



VS11 Small  
Georgian Bar

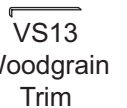

VS13  
Woodgrain  
Trim

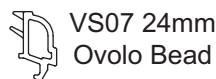

VS07 24mm  
Ovolo Bead



VS12 Large  
Georgian Bar

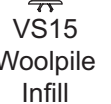

VS15  
Woolpile  
Infill

**STANDARD CONFIGURATION (VERTICAL SECTION)**

**TYPICAL VERTICAL SLIDING WINDOW**

**SPECIFICATION**

Small Top Sash  
Standard Bottom Sash  
Deep Bottom Rail Sash  
Co-extruded 24mm Glazing Bead  
Standard Cill  
Steel/Aluminium Reinforcing

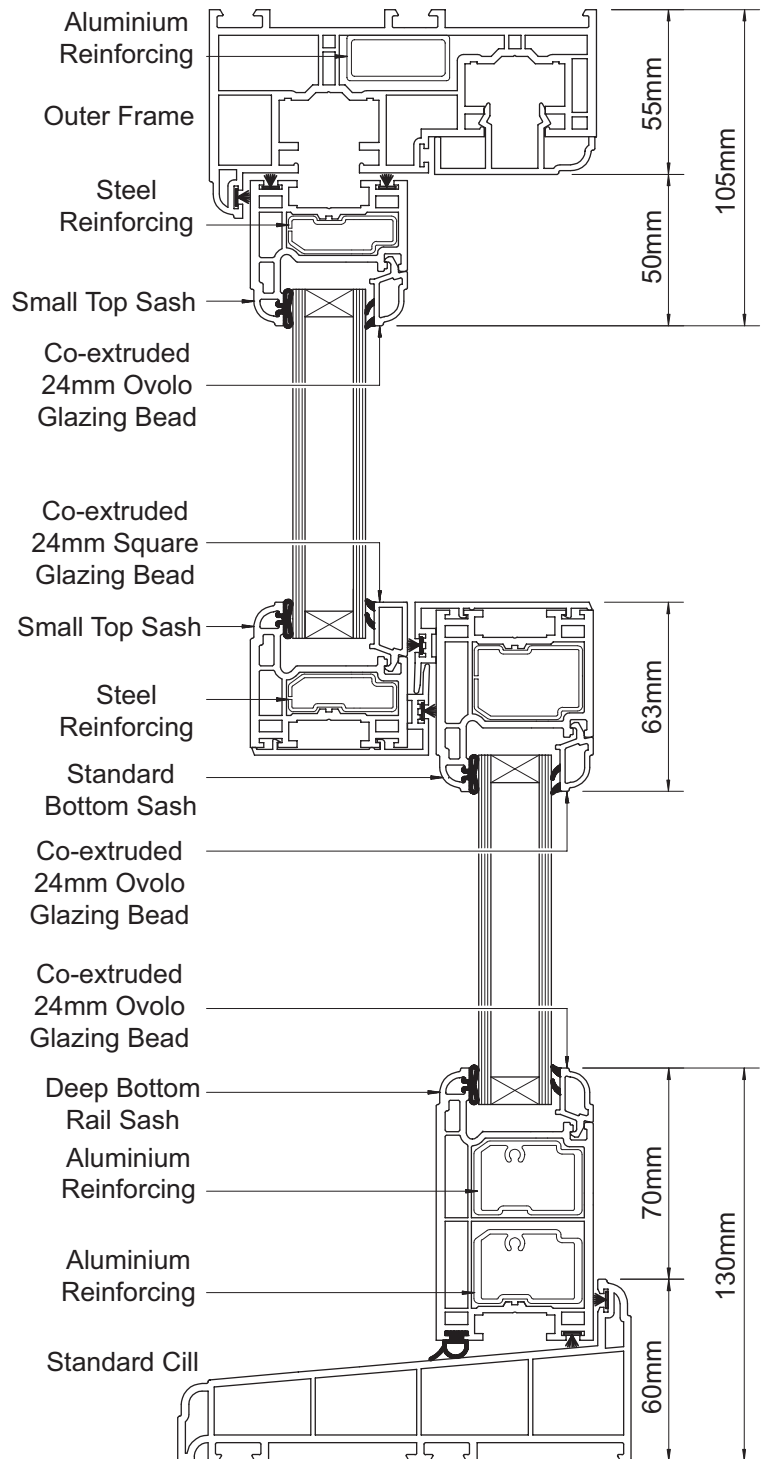
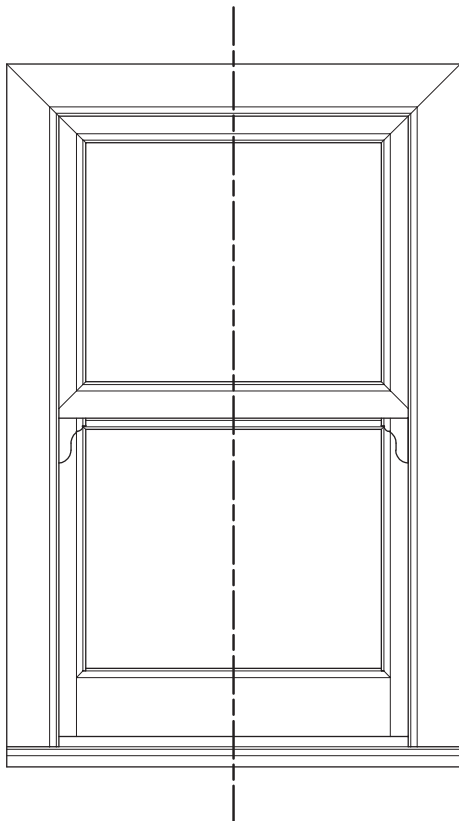



**STANDARD CONFIGURATION (HORIZONTAL SECTION)**

**TYPICAL VERTICAL SLIDING WINDOW**

**SPECIFICATION**

Small Top Sash  
Standard Bottom Sash  
Co-extruded 24mm Glazing Bead  
Steel/Aluminium Reinforcing

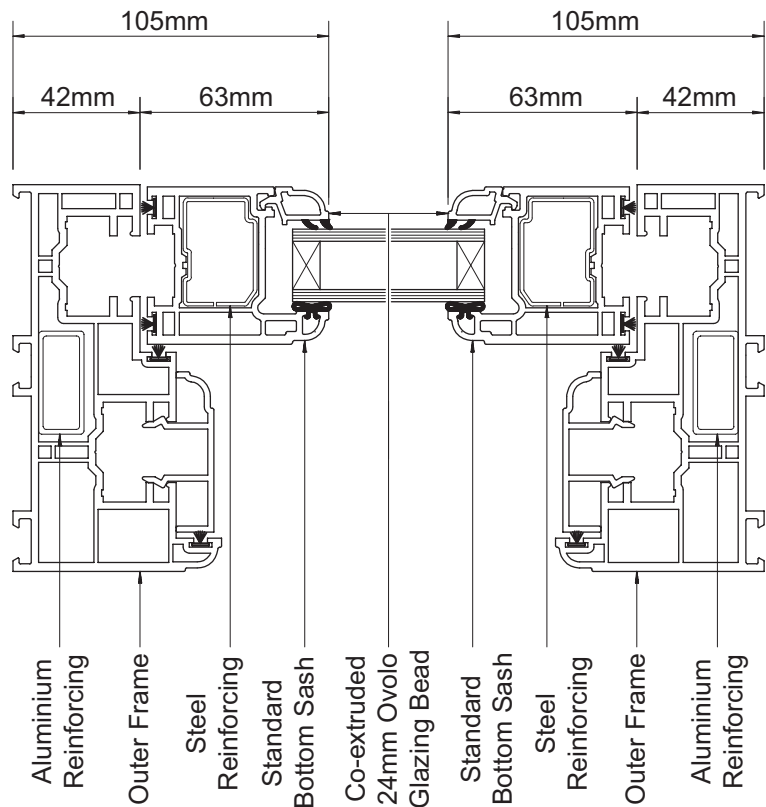
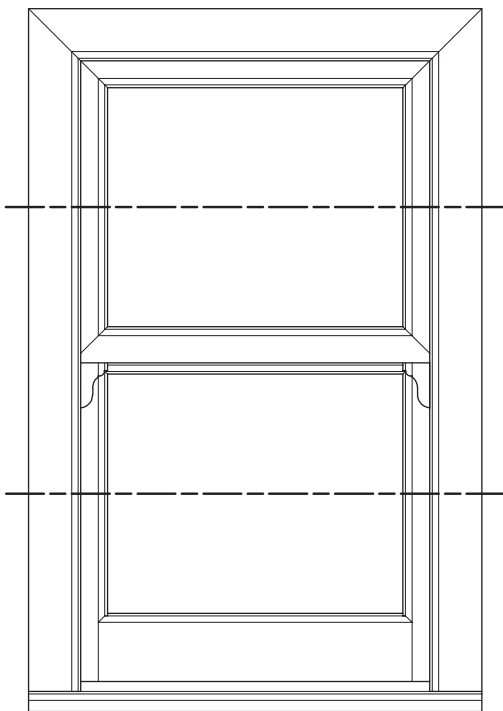
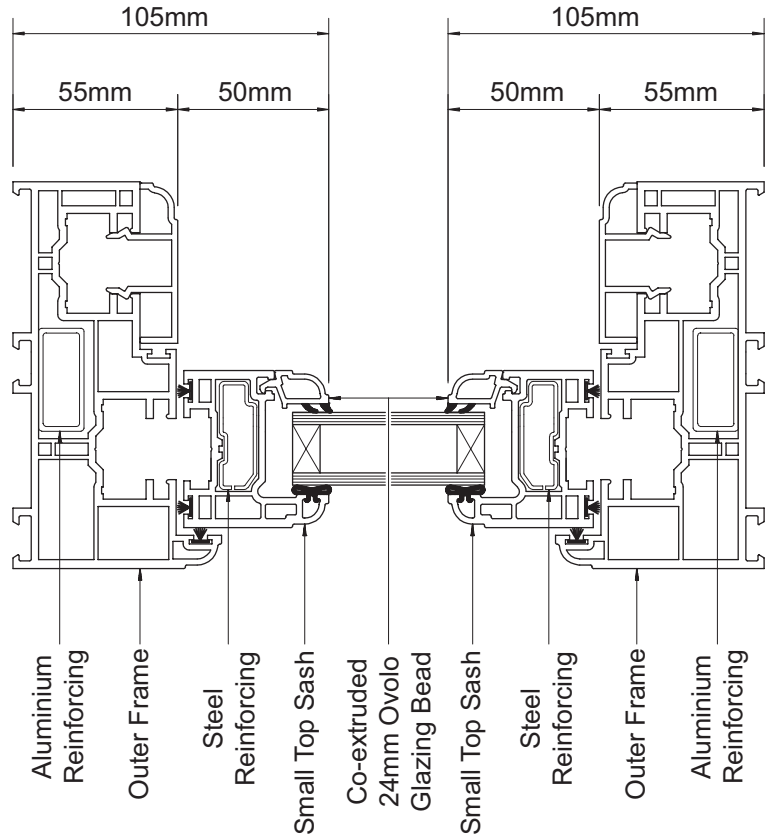

**HEAVY DUTY CONFIGURATION (VERTICAL SECTION)**

**TYPICAL VERTICAL SLIDING WINDOW**

**SPECIFICATION**

Standard Top Sash  
Standard Bottom Sash  
Deep Bottom Rail Sash  
Co-extruded 24mm Glazing Bead  
Standard Cill  
Steel/Aluminium Reinforcing

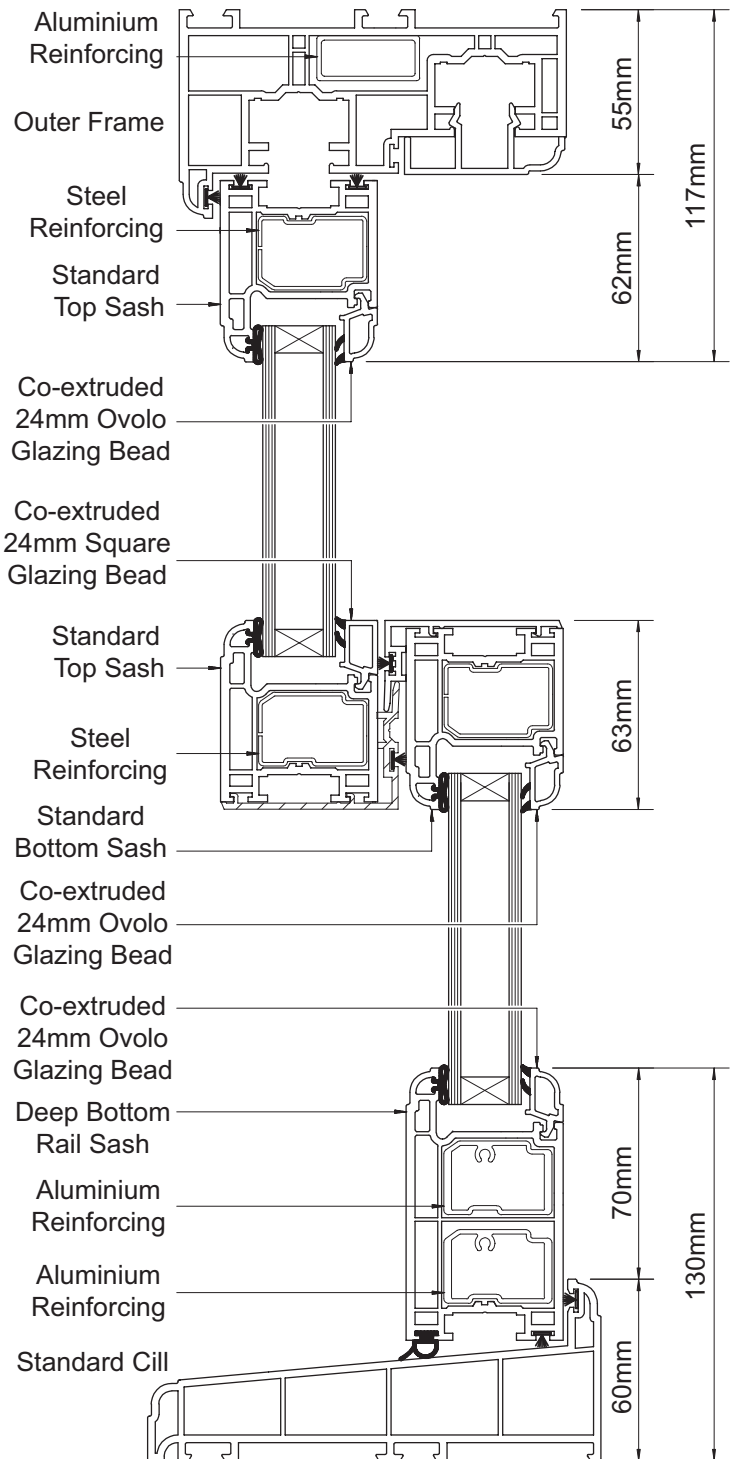
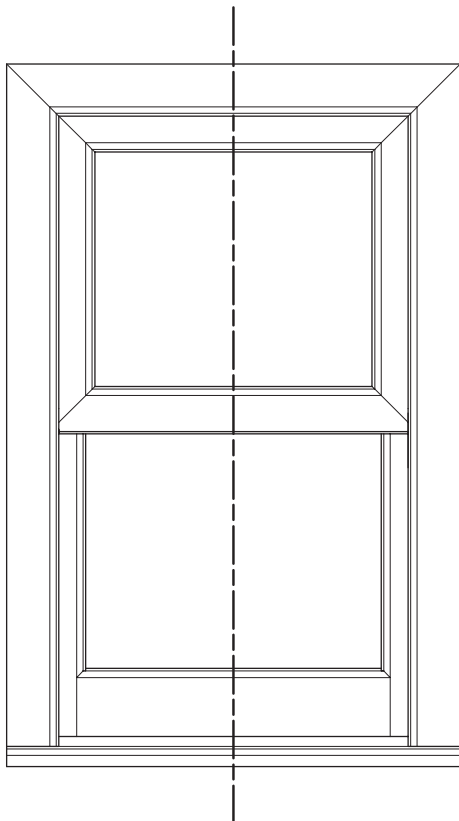

**HEAVY DUTY CONFIGURATION (HORIZONTAL SECTION)**

**TYPICAL VERTICAL SLIDING WINDOW**

**SPECIFICATION**

Standard Top Sash  
Standard Bottom Sash  
Co-extruded 24mm Glazing Bead  
Steel/Aluminium Reinforcing

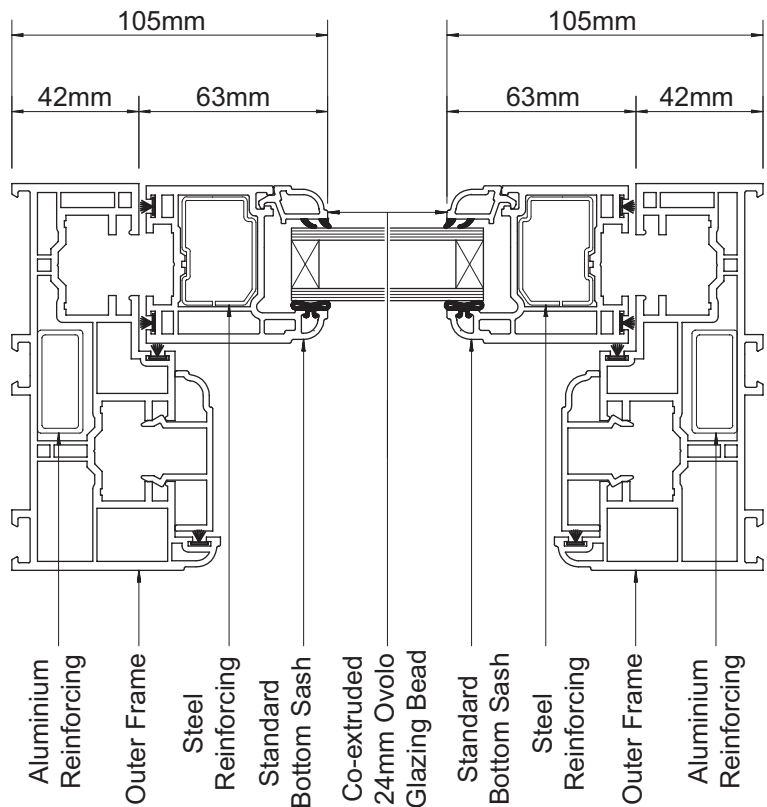
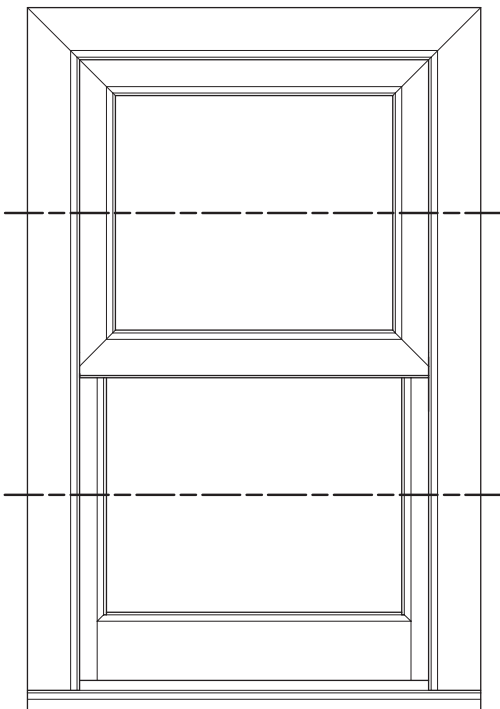
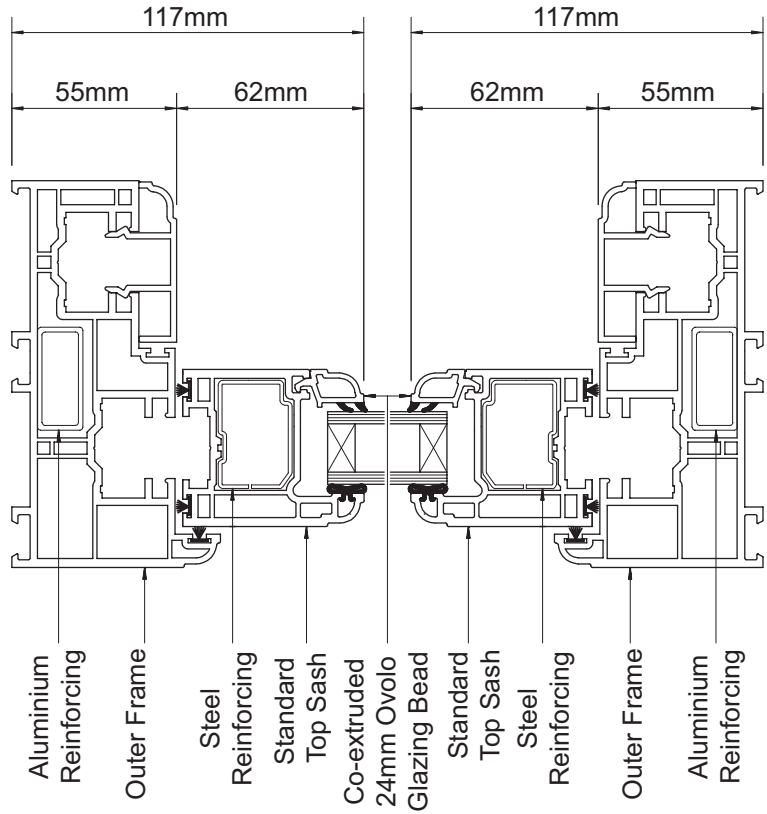





NYMNPA

02/07/2024

*Legacy*

PVCu Sliding Sash Windows





**Spectus**<sup>®</sup>  
WINDOW SYSTEMS



# Period Style

The *Legacy* PVCu sliding sash windows carry all the beauty of a traditional design, combined with modern industry thinking that not only enhance the ease of fabrication and installation but also the day-to-day use. From near-invisible joints, the elegance of the run-through sash horn to the curvy ovolo frame shape, these are just a handful of the many clever details that work together to create the most graceful and advanced sliding sash window on the market.

With the rise of PVCu sliding sash windows being specified in premium developments, as homeowners recognise not only the elegance of this traditional style, but also its superior weather performance, new design options incl. colours have been introduced, providing additional choice. Also, our stunning hardware range has become an art form, underpinned by underlying strength and security.



## Contents

The Finer Details .....	Page 3
Thermal Efficiency .....	Page 4
Security .....	Page 5
Features .....	Page 7
Hardware .....	Page 10
Colour Options .....	Page 11
Obscure Glass.....	Page 11
Styles & Shapes .....	Page 12
Technical Info .....	Page 13

# The Finer Details

---

Our PVCu sliding sash windows hold a host of impressive features that not only add to its good looks, but also enhance the performance of the window. All parts of the stunning system has the crucial ovolo shape adding traditional character like no other.



## Planning and Conservation

We're often faced with projects that require special features to fit in with the unique character of a conservation area. In the past, many planners used to refuse applications to replace timber sashes with a PVCu alternative. However, the *Legacy* sash window has been designed to recreate tradition, which has led to an increasing number of approvals granted.

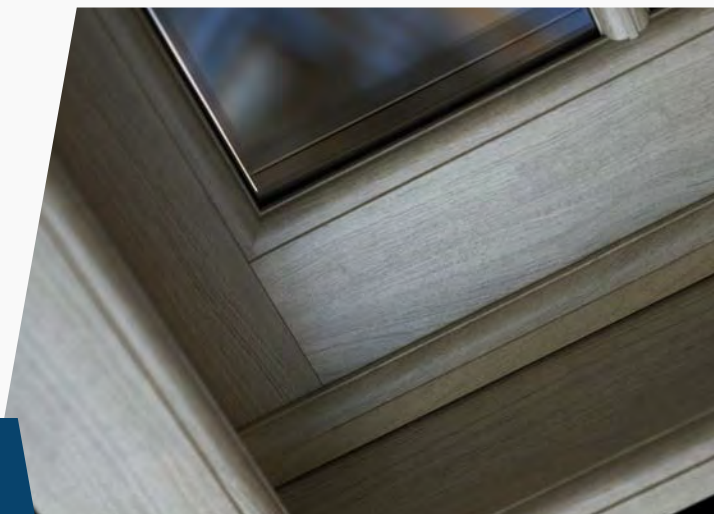



# Exceptional Thermal Efficiency

---

With fuel prices constantly on the rise, thermal performance is crucial. The window frames are built to last and to resist the ever-changing conditions the British weather throws at them without losing their immaculate appearance. An innovative dedicated weather bar adds another level of defense against rainwater; a feature unique to this type of window.



## A Energy Rating Available

The frames and sashes are multichambered, using the power of air as an insulator to stop warmth escaping. Our sash windows are available with 24mm argon gas filled double glazed units enabling them to achieve an outstanding energy rating of 'A' with a u-value of 1.4W/m<sup>2</sup>K.

The efficient air filled sash window unit achieves an energy rating of 'B' as standard and a u-value of 1.6W/m<sup>2</sup>K.

## Colourmatching Woolpile

The sash windows feature woolpile strips that provide an excellent seal against weather, air and debris infiltration. We've paid attention to every detail and as something new we've introduced colourmatching woolpile to ensure that every single window is perfectly finished.

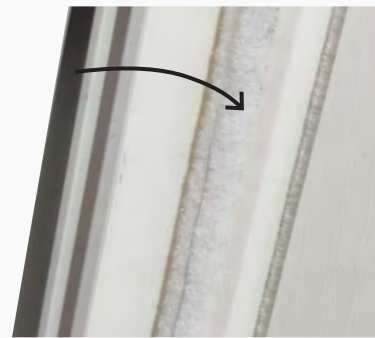

## Recyclability

PVCu can be recycled over and over again, without any deterioration in performance. PVCu is an environmentally friendly choice as most PVCu windows will be recycled.

By choosing our sliding sash windows you can keep your home warm all year round, reduce your heating bills as well as helping the environment.



# Peace of Mind

---

Our sash windows deliver the most advanced levels of security without adding complex operation. They are practical and come with all the safety features you would expect from a modern window solution. The window is secured using a snail cam fitted to the top face of the bottom sash. By turning the lever you release the cam from its keep. You have the option of choosing a key-locking or non-locking system.

Our traditional sash window is backed up by an impressive list of accreditations:

- Kitemarked to BS EN 12608 and PAS 24
- Produced entirely in the UK
- Compliant with Building Regulations
- 10-year manufacturing guarantee



## PAS 24 Security Upgrade

Upgrade the security of your sliding sash windows by taking advantage of our comprehensive PAS 24:2016 security package. The upgrade is available on windows with 45° welded joints as well as on our traditional fully mechanical jointed option. The enhancement includes the below four upgrades. A PAS 24 upgrade is generally mandatory on new-build projects. Please note that the upgrade is not standard and must be requested as part of the window specification.



Reinforced  
Tilt Latches



Upgraded  
Locking Keep



Upgraded  
Lock

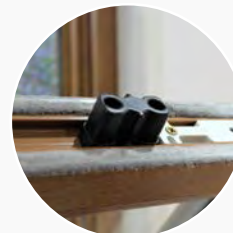

Top Sash  
Security Blocks





# Legacy Features

---

With our *Legacy* sash windows, you can respect the traditions, admire the woodworker's art and enjoy modern advances that make your home warm and secure. From a terraced house to a stately home, our sash windows can help ensure that your property retains its character and charm. You can choose from a wide range of styles, features and hardware options to complement your home.



## Slide & Tilt Facility

Both the top and bottom sashes can slide up and down for ventilation. An easy clean clean tilt facility allowing you to clean your windows from inside your home is available. Please note certain specifications do not allow for these features.

## Sash Horns

Enhance your window by choosing either run-through or plant-on sash horns. The run-through utilises mechanical joints rather than welded to allow the horn to be a continuous part of the sash giving the window a more authentic overall look.

The plant-on is a sculptured moulding that is fixed to the underside of the top sash.

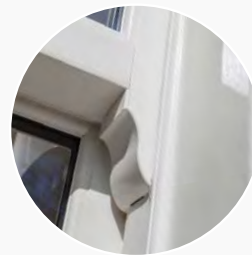

Run-through

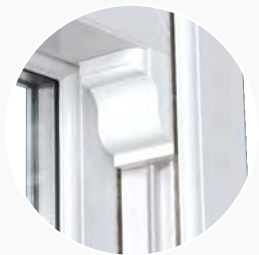

Plant-on



## Mechanical Joints

The fully mechanical joints take authenticity to another level because the 45 degree PVCu welds on the frame and sash are replaced with 90 degree mechanical joints as found on traditional timber windows.

## Seamless Welds

This revolutionary process disguises the external 45-degree corner welds with a flush mitre providing a far superior aesthetic finish. Available on woodgrain windows only and a minimum window size of 475mm wide x 900mm high.

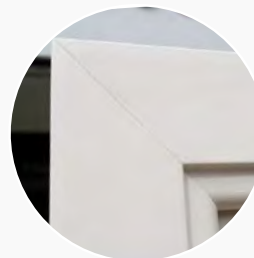

## Astragal Bars

Include a bar layout on your new sash windows for added character and design that looks as close to the original as possible. Astragal bars are fixed onto the surface of the glass and are accompanied by back to back spacer bars inside the double glazed unit.

\*Please note that on windows with a woodgrain finish external and smooth finish internal we are not able to offer top sash tilt facility.



## *Deep Bottom Rail*

Choose a deep bottom rail if you want your sliding sash windows to look as close to the original timber version as possible. The larger bottom rail sash convincingly mimics the timber sash windows of old.

The deep bottom rail is available with welded or mechanical joints.



## *Weather Bar*

The sash window boasts an innovative weather bar that not only offer authentic period aesthetics but also add another level of defense against rain and wind. The ovolo shaped weather bar replicates the sashes and outer frame, and is the latest of our design features, developed to create an authentic sash window appearance.





# Hardware

## Travel Restrictors

The travel restrictors limit the opening of the top and bottom sashes to approximately 100mm. They are primarily used as a safety feature in locations where opening restrictions are needed. The magnetic mechanism can be overridden from inside your home allowing for a larger opening.

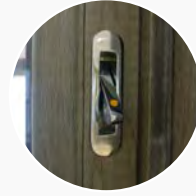

## Lift Hook

All our PVCu sliding sash windows come with one or two lift hooks as standard depending on window size. The lift hooks are usually fitted on the inside of the bottom sash to allow for easy opening.

## D-Handle

Designed to be fitted to the underside of the top sash on the outside of the window to assist with the opening and closing of the window. Alternatively, you can request the D-handle to be fitted to the inside top sash.



## Pole Eye

Primarily designed to be fitted to the top rail of the top sash. The pole eye enables use of a pole with hook (not supplied) to operate any windows that are positioned too high to operate by hand.

## Locking System

Our locking system holds the sash window shut by fastening the mid-rails together. The locking system is available in two styles.



Standard



Heritage



Standard



Heritage

## Sash Knob

Used to open and tilt the sashes for easy cleaning of the outside frame and glass from inside your home.

## Hardware Colours

Our hardware is available in eight different finishes. Please note that our travel restrictors are only available in white, chrome, gold and satin chrome.



White

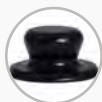

Black

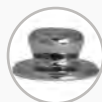

Chrome

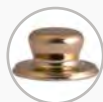

Gold



Satin Chrome



Graphite

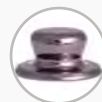

Bronze

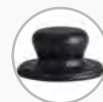

Antique Black

# Colour Options

Our sliding sash windows are available in 13 standard woodgrain colourways. By choosing a woodgrain foiled finish you are able to bring your windows to life with a glossy, freshly painted, realistic timber effect.



# Bespoke Colour Bonding

If you're looking to add a true personalised touch to your new windows, we offer a bespoke colour bonding service in which you can choose between 100s of colours in either a smooth or woodgrain finish. Some of our most popular RAL colours are shown below. Please note that lighter / darker shades are available and we're always happy to help you find the perfect colour to suit your home. Just ask!



# Obscure Glass

Obscure glass is typically utilised in bathrooms, shower rooms and other private areas. Our sliding sash windows can be specified with a variety of different glass patterns and obscurity levels to suit your needs.





# Styles and Shapes

Our *Legacy* sliding sash windows can be manufactured to a style to suit your home. Below are a few examples of the different bar layouts available. Our windows come with equal sized top and bottom sashes (50/50 split) as standard, however we are able to manufacture other split ratios at your request (minimum transom drop of 350mm). Please get in touch if you require a bespoke style or bar layout.

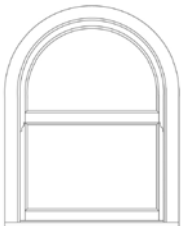

True Arch\*

## Seamless True Arch

PVCu sliding sash windows are notoriously difficult to work with when it comes to bending profiles and we're therefore very proud to be able to offer a true arched PVCu sash window with no welded joints in the frame.

## Coupled & Bay Windows

Coupled- and bay windows are both very popular for large openings as they open up the living space and bring in natural light.

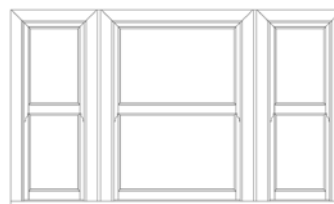

Coupled Windows

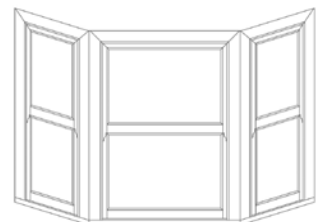

Bay Windows

\*Please note that on swept heads and arched frames the top sash will always be fixed.



# Technical Info

Our technical information section covers manufacturing limitations and detailed technical drawings. To most people the technical drawings don't make much sense, so if you have any questions our product experts will be more than happy to explain in more detail.

## Technical Specifications

Front to back dimensions: 128mm  
Glazing units: 24mm double glazed  
U-value: 1.4W/m<sup>2</sup>K - 1.6W/m<sup>2</sup>K

## Manufacturing Limitations

Minimum width: 360mm  
Maximum width: 1500mm  
Minimum height: 750mm  
Maximum height: 2350mm

## Technical Drawings

### Main Profiles

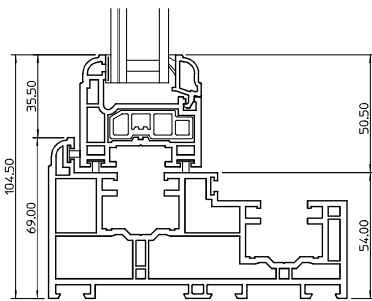

Top Jamb

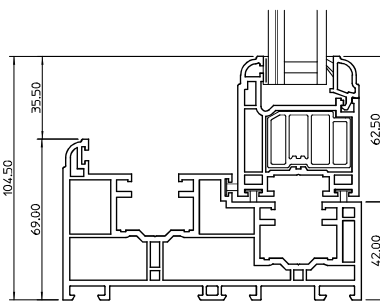

Bottom Jamb

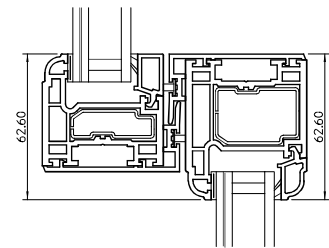

Meeting Rail

### Sills

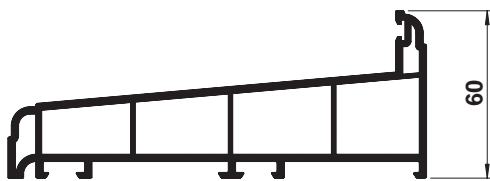

150mm Sill

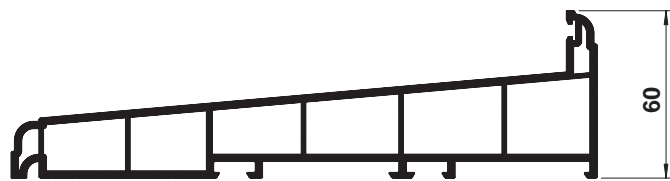

210mm Sill

### Ancillaries

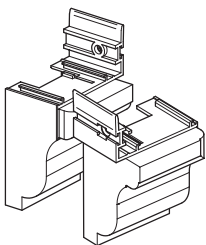

Plant-on Sash Horn

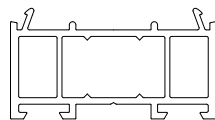

30mm Add on

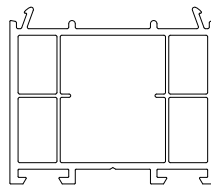

50mm Add on

Please note that some slide and tilt restrictions may apply on very large/small and bespoke shaped windows.



The images, drawings and data shown in this brochure are for illustrative purposes only and are not binding in detail, colour or specification. We reserve the right to make changes to the product specification as technical developments dictate and without prior notice.



