

HUNGATE JOINERY WORKS - RECREATION ROAD - PICKERING - N. YORKSHIRE - YO18 7DA

Email:

Mr & Mrs Peirson
Friarhouse Farm
Darnholme Road
Goathland

ESTIMATE

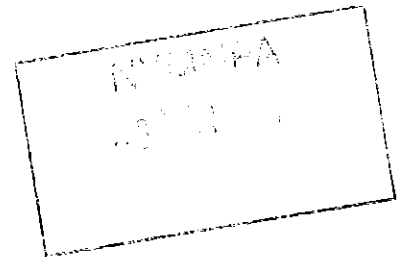

Reference	Hardwood
Estimate Number	JMS1/1056
Date of Estimate	1 September 2016
Validity	30 days

Dear Mr & Mrs Peirson

Further to your enquiry we have pleasure in submitting our estimate for the SUPPLY ONLY of the following joinery items.

Below is a detailed specification.

Ironmongery and hardware finish is at the discretion of S.Taylor & Son Ltd if not informed before manufacture.

Sapele hardwood windows. 4.6.4 Timbalite slim double glazed units. Fully factory finished in white. Brass fasteners

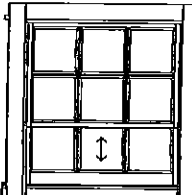
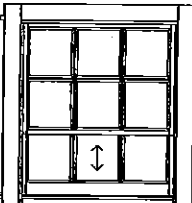
Item	Description	Number	Width	Height	Total Cost
	<p>Sliding Sash Ground Floor Front: Lounge & Kitchen Traditional Box Windows, 26mm bars, 14mm Timbalite double glazed units supplied loose, weights supplied loose, fasteners, draughtseals TIMBER: Sapele 4/6/4 Timbalite low E double glazing, clear, Krypton gas filled, 1.4 centre pane u-value (0.30 m2 minimum) Treat and apply 3 coats of paint (Satin finish) 84.07 kgs</p>	2	950mm	950mm	①
	<p>Sliding Sash First Floor Front: Bedrooms Traditional Box Windows, 26mm bars, 14mm Timbalite double glazed units supplied loose, weights supplied loose, fasteners, draughtseals TIMBER: Sapele 4/6/4 Timbalite low E double glazing, clear, Krypton gas filled, 1.4 centre pane u-value (0.30 m2 minimum) 4/6/4 Timbalite low E double glazing, toughened, clear, Krypton gas filled, 1.4 centre pane u-value (0.30 m2 minimum) Treat and apply 3 coats of paint (Satin finish) 87.33 kgs</p>	2	950mm	1000mm	②

Carried Forward

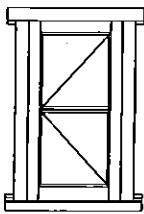
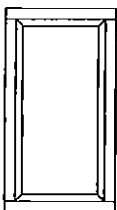
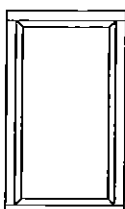
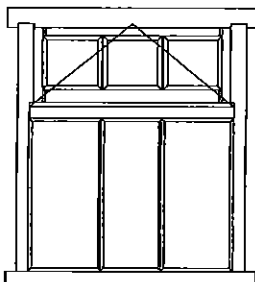
Item	Description	Number	Width	Height	Total Cost
		Brought Forward			
	Window Lounge Casement window, traditional type with inset flush sashes, fully glazed, 26mm wide conventional glazing bars, glazing beads, opening sashes hung on stainless steel butt hinges, draughtseals, our standard fasteners fitted TIMBER: Sapele 4/6/4 Timbalite low E double glazing, clear, Krypton gas filled, 1.4 centre pane u-value (0.30 m2 minimum) Treat and apply 3 coats of paint (Satin finish) 19.45 kgs	1	510mm	860mm	
		(3)			
	Window Kitchen Slit window, outerframe only, direct glazed TIMBER: Sapele 4/6/4 Timbalite low E double glazing, clear, Krypton gas filled, 1.4 centre pane u-value (0.30 m2 minimum) Treat and apply 3 coats of paint (Satin finish) 4.61 kgs	1	280mm	510mm	
		(4)			
	Window WC Slit window, outerframe only, direct glazed TIMBER: Sapele 4/6/4 Timbalite low E double glazing, obscure, Krypton gas filled, 1.4 centre pane u-value (0.30 m2 minimum) Treat and apply 3 coats of paint (Satin finish) 5.69 kgs	1	330mm	560mm	
		(5)			
Window		1	820mm	990mm	
Front	Traditional 'hopper' type windows, fully glazed, 26mm glazing bars, opening sashes bottom hinged on butt hinges, tilt-in, draughtseals TIMBER: Sapele 4/6/4 Timbalite low E double glazing, toughened, clear, Krypton gas filled, 1.4 centre pane u-value (0.30 m2 minimum) Treat and apply 3 coats of paint (Satin finish) 31.32 kgs				
		(6)			

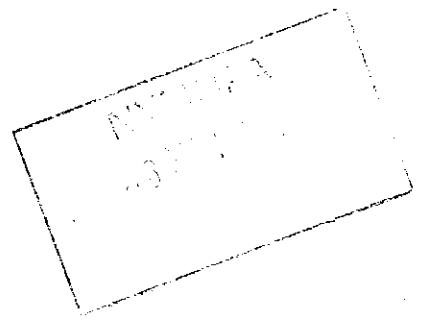

Carried Forward

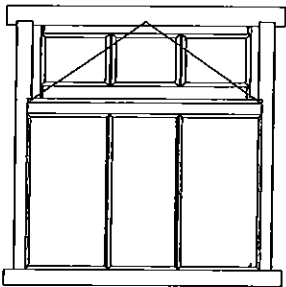
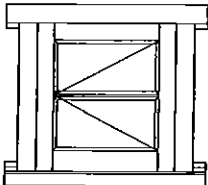
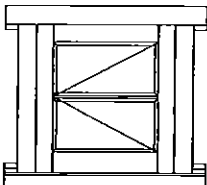
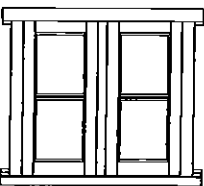
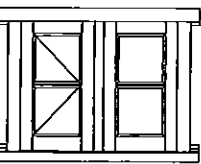
Item	Description	Number	Width	Height	Total Cost
		Brought Forward			
Window		2	940mm	1010mm	
	Side & Rear Traditional 'hopper' type windows, fully glazed, 26mm glazing bars, opening sashes bottom hinged on butt hinges, tilt-in, draughtseals TIMBER: Sapele 4/6/4 Timbalite low E double glazing, toughened, clear, Krypton gas filled, 1.4 centre pane u-value (0.30 m2 minimum) Treat and apply 3 coats of paint (Satin finish) 70.83 kgs				
					7
Window		2	520mm	530mm	
	Rear Upstairs Casement window, traditional type with inset flush sashes, fully glazed, 26mm wide conventional glazing bars, glazing beads, opening sashes hung on stainless steel butt hinges, draughtseals, our standard fasteners fitted TIMBER: Sapele 4/6/4 Timbalite low E double glazing, clear, Krypton gas filled, 1.4 centre pane u-value (0.30 m2 minimum) Treat and apply 3 coats of paint (Satin finish) 28.28 kgs				
					8
Window		1	520mm	530mm	
	Rear Bathroom Casement window, traditional type with inset flush sashes, fully glazed, 26mm wide conventional glazing bars, glazing beads, opening sashes hung on stainless steel butt hinges, draughtseals, our standard fasteners fitted TIMBER: Sapele 4/6/4 Timbalite low E double glazing, obscure, Krypton gas filled, 1.4 centre pane u-value (0.30 m2 minimum) Treat and apply 3 coats of paint (Satin finish) 14.14 kgs				
					9
Window		1	800mm	760mm	
	Rear Downstairs Casement window, traditional type with inset flush sashes, fully glazed, 26mm wide conventional glazing bars, glazing beads, non-opening TIMBER: Sapele 4/6/4 Timbalite low E double glazing, clear, Krypton gas filled, 1.4 centre pane u-value (0.30 m2 minimum) Treat and apply 3 coats of paint (Satin finish) 27.43 kgs				
					10
Window		1	760mm	630mm	
	Rear Lounge Casement window, traditional type with inset flush sashes, fully glazed, 26mm wide conventional glazing bars, glazing beads, opening sashes hung on stainless steel butt hinges, draughtseals, our standard fasteners fitted TIMBER: Sapele 4/6/4 Timbalite low E double glazing, clear, Krypton gas filled, 1.4 centre pane u-value (0.30 m2 minimum) Treat and apply 3 coats of paint (Satin finish) 23.26 kgs				
					11

Carried Forward

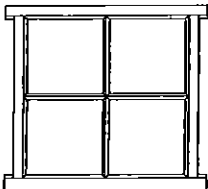
Item	Description	Number	Width	Height	Total Cost
	Window Lean-to outbuilding Single Glazing, no opening TIMBER: Sapele 4mm Clear Toughened Float glass (0.25 m2 minimum) Treat and apply 3 coats of paint (Satin finish) 15.11 kgs	1	800mm	800mm	£279.75

					VAT @ 20%

					Total
					=====

12

Total Weight 411.52 kgs

NOTES:

Diagrams of windows, doors and frames indicate style viewed from the outside and do not reflect size. Other diagrams are showing a section through or a generic view.
All our external double glazed and insulated joinery items are CE marked and equal or exceed current building regulation u-value ratings. Certificates showing u-values are available on request.

We use Accoya for all our painted external glazing beads and applied bars. See our website for information on Accoya. Please use Stainless Steel fixings.

This is our best interpretation of your requirements and by placing an order you are confirming all sizes, quantities and styles are correct.

Shrink wrapping is available at a cost of £7.50 per item.

Please ring with any queries.

Yours sincerely

Robert Taylor
(For S. Taylor & Son Ltd)

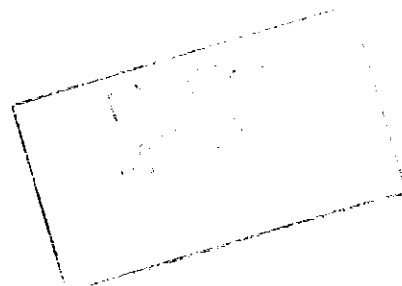



S. TAYLOR & SON LTD

Hungate Joinery Works, Recreation Road, Pickering, North Yorkshire. YO18 7DA

Drawing showing sections of our casement windows

With inset sashes

Rebated for 14mm Timbalite Slimline Double Glazing with Glazing beads

(Minimum 10mm deep rebate required to cover trays)

Section through Sill, Head
Sash Top & Bottom Rails
& Glazing Bar

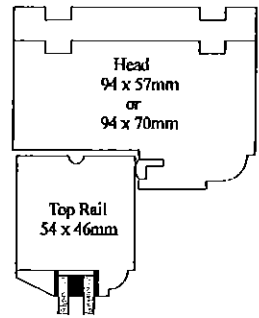

Section through Jamb, Mullion,
Sash Stiles & Glazing Bar

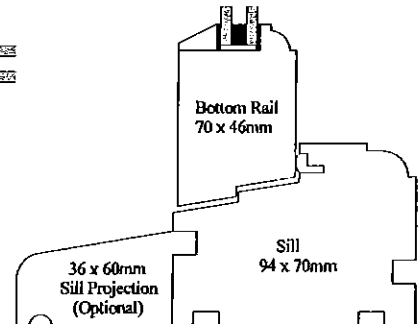
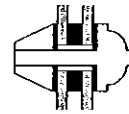
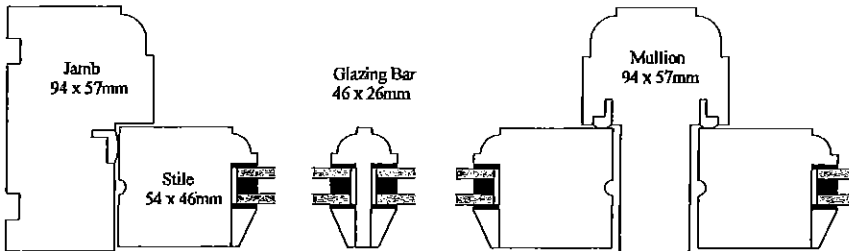

Scale 1:2 @A4

S. TAYLOR & SON LTD

Hungate Joinery Works, Recreation Road, Pickering, North Yorkshire. YO18 7DA

Drawing showing sections of our casement windows
With inset sashes

Rebated for 14mm Timbalite Slimline Double Glazing with Glazing beads
(Minimum 10mm deep rebate required to cover trays)

Section through Sill, Head
Sash Top & Bottom Rails
& Glazing Bar

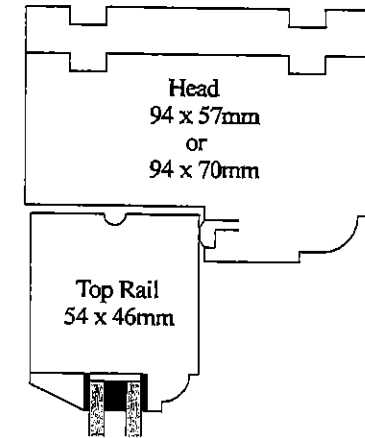

Section through Jamb, Mullion,
Sash Stiles & Glazing Bar

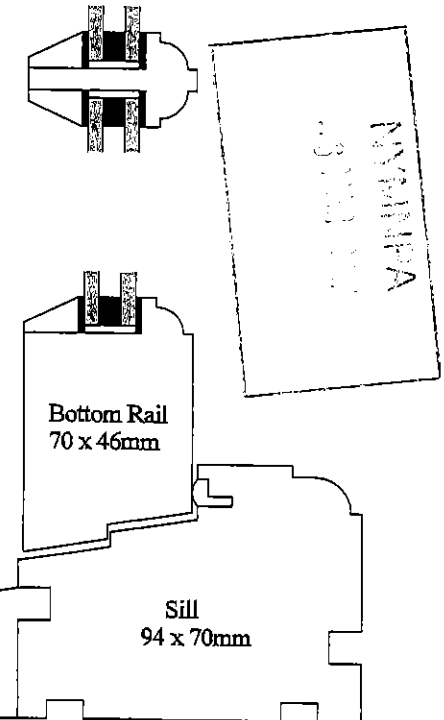
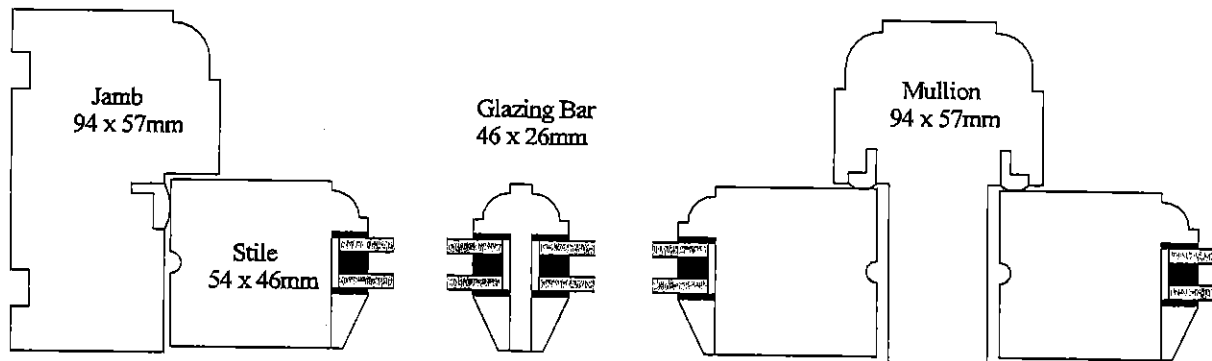

Scale 1 : 2 @A4

S. TAYLOR & SON LTD

Recreation Road, Pickering, North Yorkshire. YO18 7DA

Timber sections for Traditional Vertical Sliding Sash Window
 Timbalite Slimline 4/6/4 (14mm) low E gas filled double glazing (1.4 centre-pane u-value)
 With glazing beads
 26mm Glazing Bars - Rebates must be 10mm deep to cover trays in double glazing
 Draughtseals to parting beads, meeting rail and bottom rail.

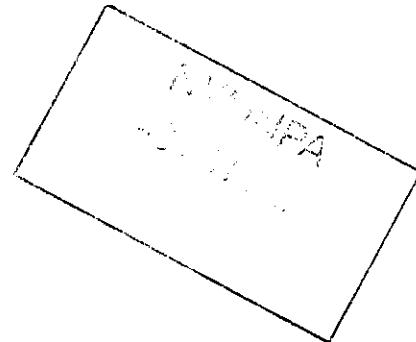
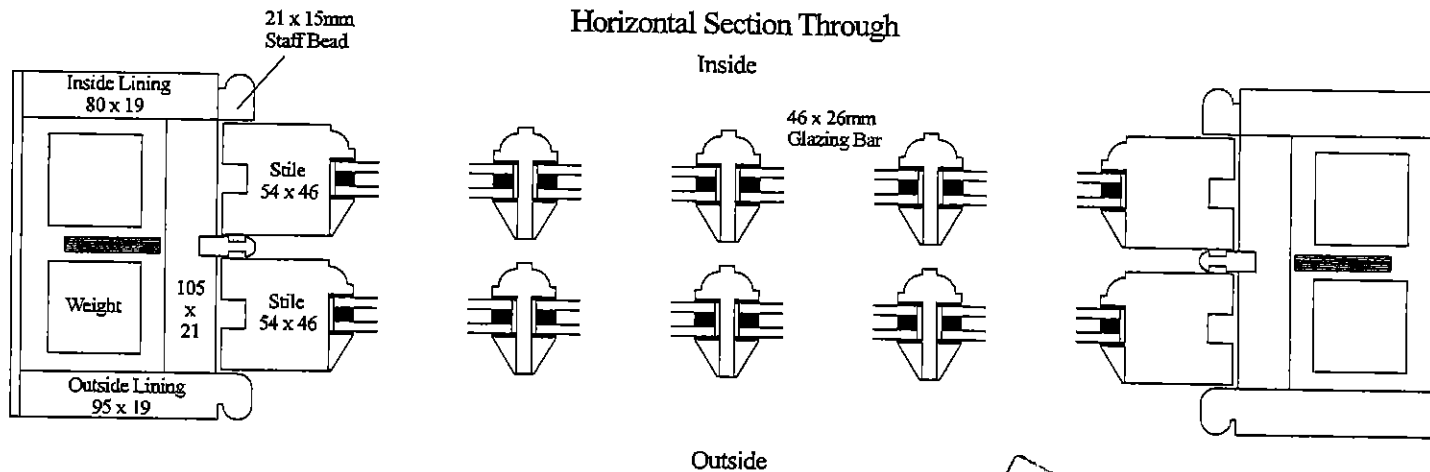
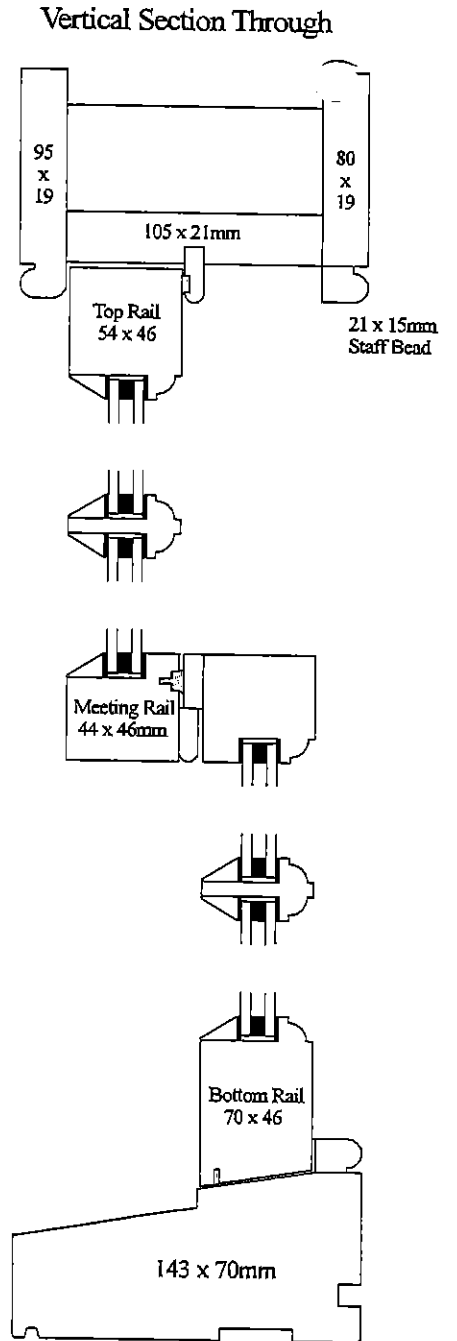

Scale 1 : 3