

NYMNP

24/09/2018

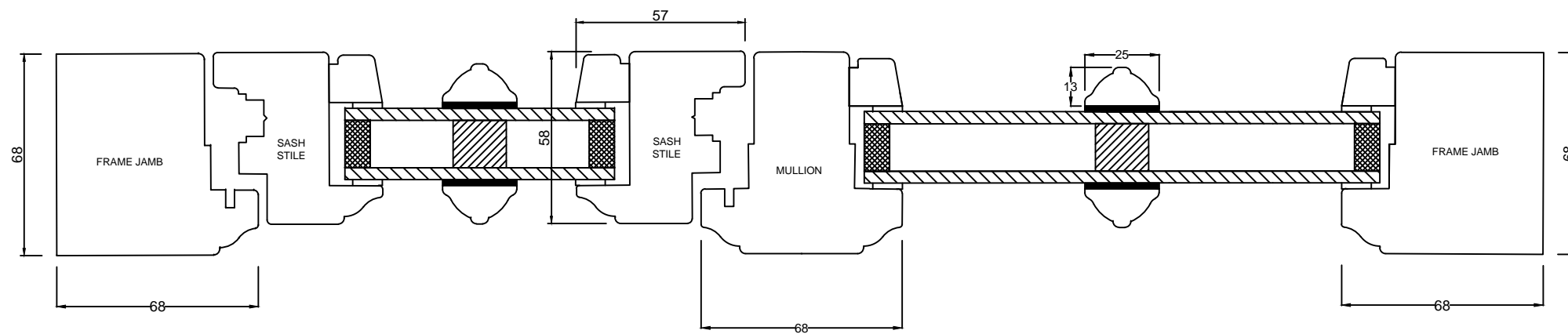

|          | BY | DATE     |
|----------|----|----------|
| DRAWN    | JD | 14/03/17 |
| CHECKED  |    |          |
| APPROVED |    |          |



**ERW Joinery Ltd**  
Skippers Lane, Skippers Lane Industrial Estate, Middlesbrough, TS6 6HA  
Tel: 01642 456167 Fax: 01642 462708 Email: info@erw ltd.co.uk www.erw ltd.co.uk

DESCRIPTION  
68MM FLUSH CASEMENT WITH 1 NO MULLION AND 1 SASH, HORIZONTAL SECTION

|            |     |             |
|------------|-----|-------------|
| SCALE      | 1:2 | DRAWING N°  |
| PAPER SIZE | A3  | ERW/001/001 |

NYMNP

24/09/2018

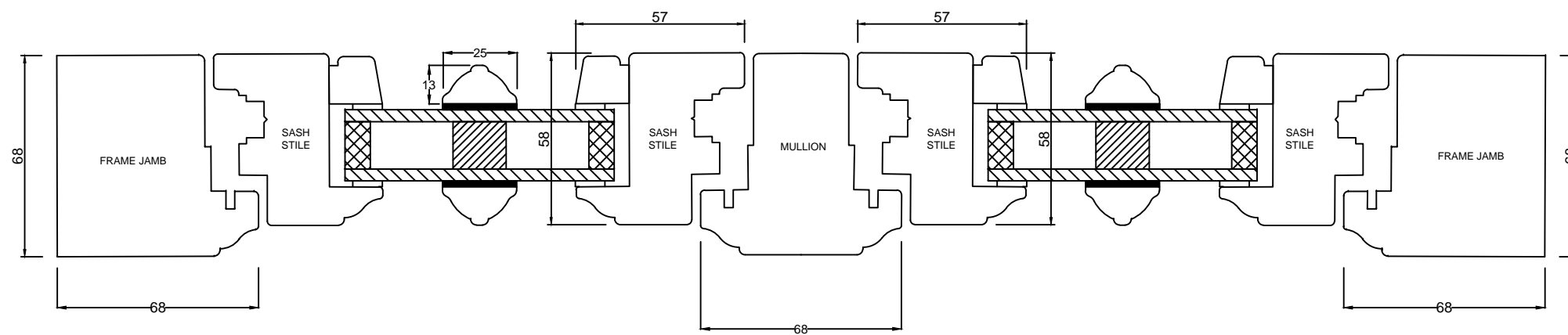

|          | BY | DATE     |
|----------|----|----------|
| DRAWN    | JD | 14/03/17 |
| CHECKED  |    |          |
| APPROVED |    |          |



**ERW Joinery Ltd**  
Skippers Lane, Skippers  
Lane Industrial Estate,  
Middlesbrough, TS6 6HA  
Tel: 01642 456167 Fax:  
01642 462708 Email:  
info@erw ltd.co.uk  
www.erw ltd.co.uk

DESCRIPTION  
68MM FLUSH CASEMENT WINDOW, 1 NO MULLION, 2 NO.  
SASHES – HORIZONTAL SECTION

|            |     |             |
|------------|-----|-------------|
| SCALE      | 1:2 | DRAWING N°  |
| PAPER SIZE | A3  | ERW/001/003 |

NYMNP

24/09/2018

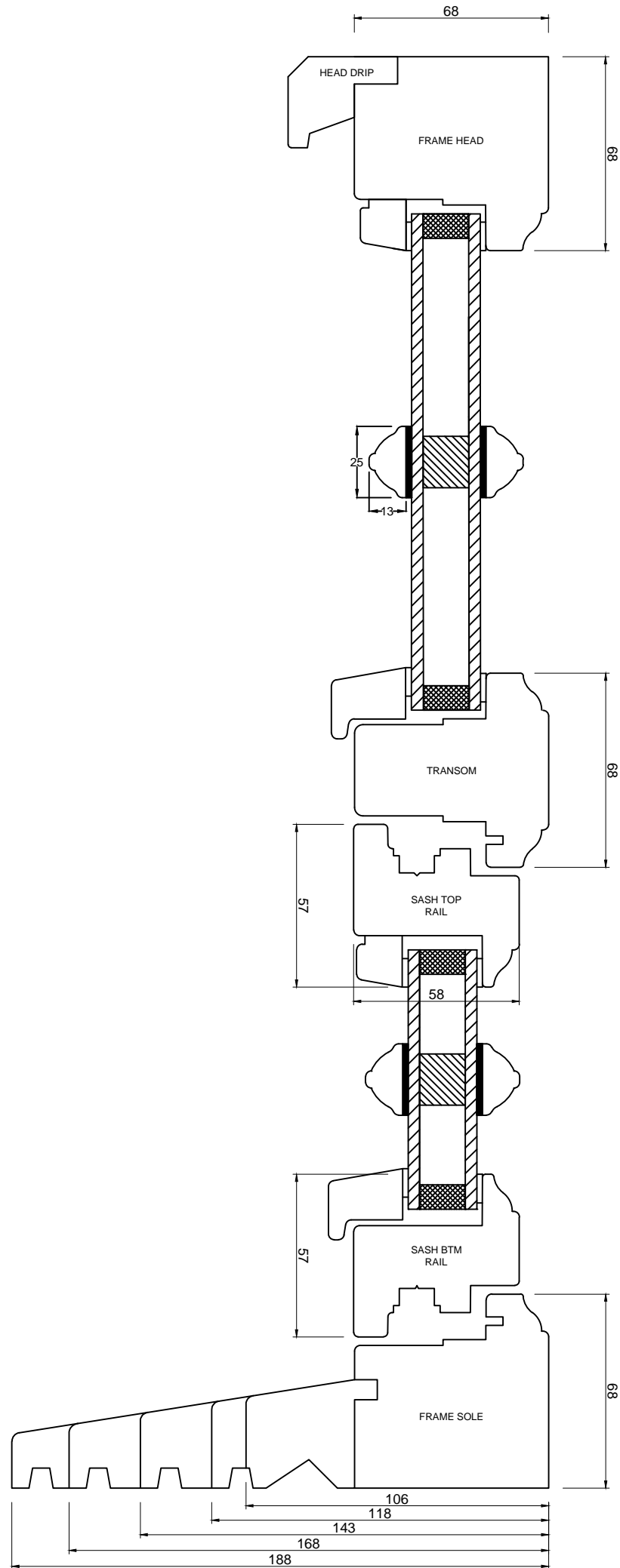

|          | BY | DATE     |
|----------|----|----------|
| DRAWN    | JD | 15/05/17 |
| CHECKED  |    |          |
| APPROVED |    |          |



**ERW Joinery Ltd**  
 Skippers Lane, Skippers  
 Lane Industrial Estate,  
 Middlesbrough, TS6 6HA  
 Tel: 01642 456167 Fax:  
 01642 462708 Email:  
 info@erw ltd.co.uk  
 www.erw ltd.co.uk

DESCRIPTION  
 68MM FLUSH CASEMENT WINDOW INC TRANSOM AND  
 1 NO SASH - VERTICAL SECTION

|            |     |                           |
|------------|-----|---------------------------|
| SCALE      | 1:2 | DRAWING N°<br>ERW/001/004 |
| PAPER SIZE | A3  |                           |

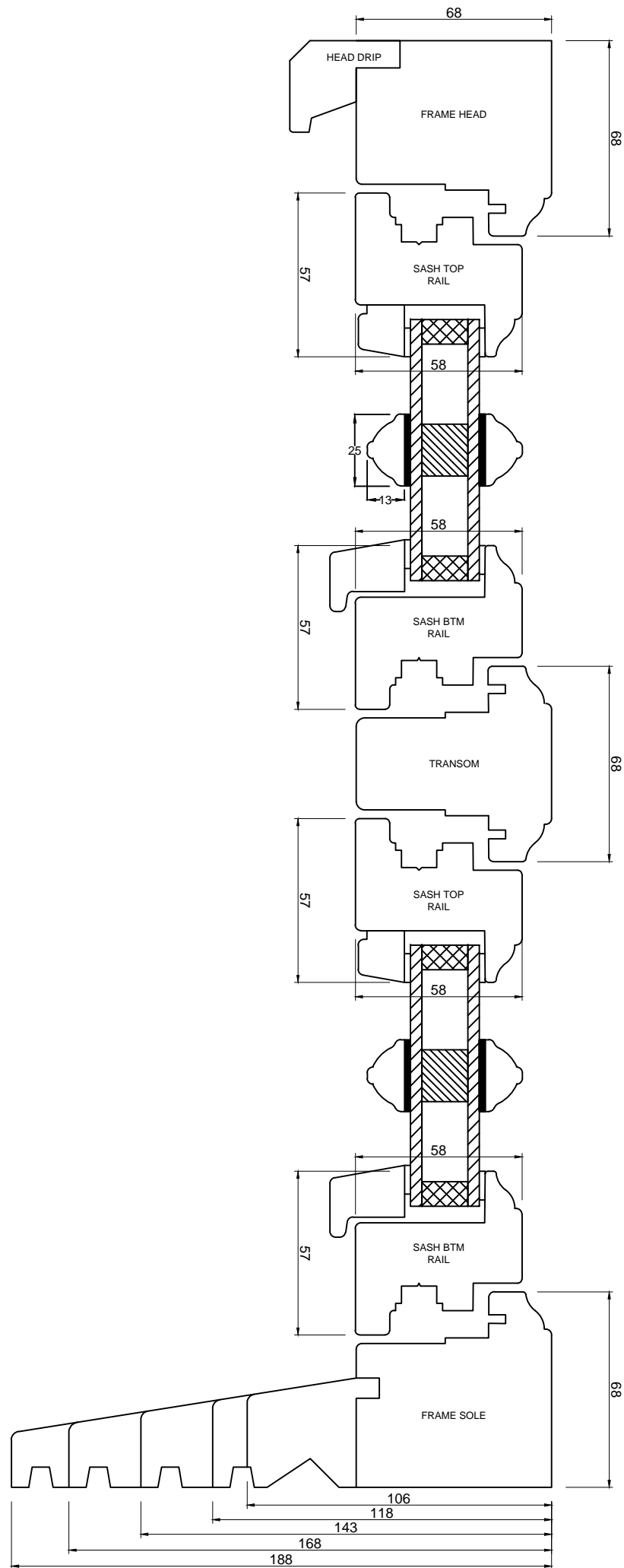

NYMNPA  
24/09/2018

|          | BY | DATE     |
|----------|----|----------|
| DRAWN    | JD | 15/05/17 |
| CHECKED  |    |          |
| APPROVED |    |          |



**ERW Joinery Ltd**  
 Skippers Lane, Skippers Lane Industrial Estate,  
 Middlesbrough, TS6 6HA  
 Tel: 01642 456167 Fax: 01642 462708 Email: info@erw ltd.co.uk  
 www.erw ltd.co.uk

DESCRIPTION  
 68MM CASEMENT WINDOW WITH 1 NO TRANSOM, 2 NO SASHES - VERTICAL SECTION

|            |     |             |
|------------|-----|-------------|
| SCALE      | 1:2 | DRAWING N°  |
| PAPER SIZE | A3  | ERW/001/006 |

NYMNPA

24/09/2018

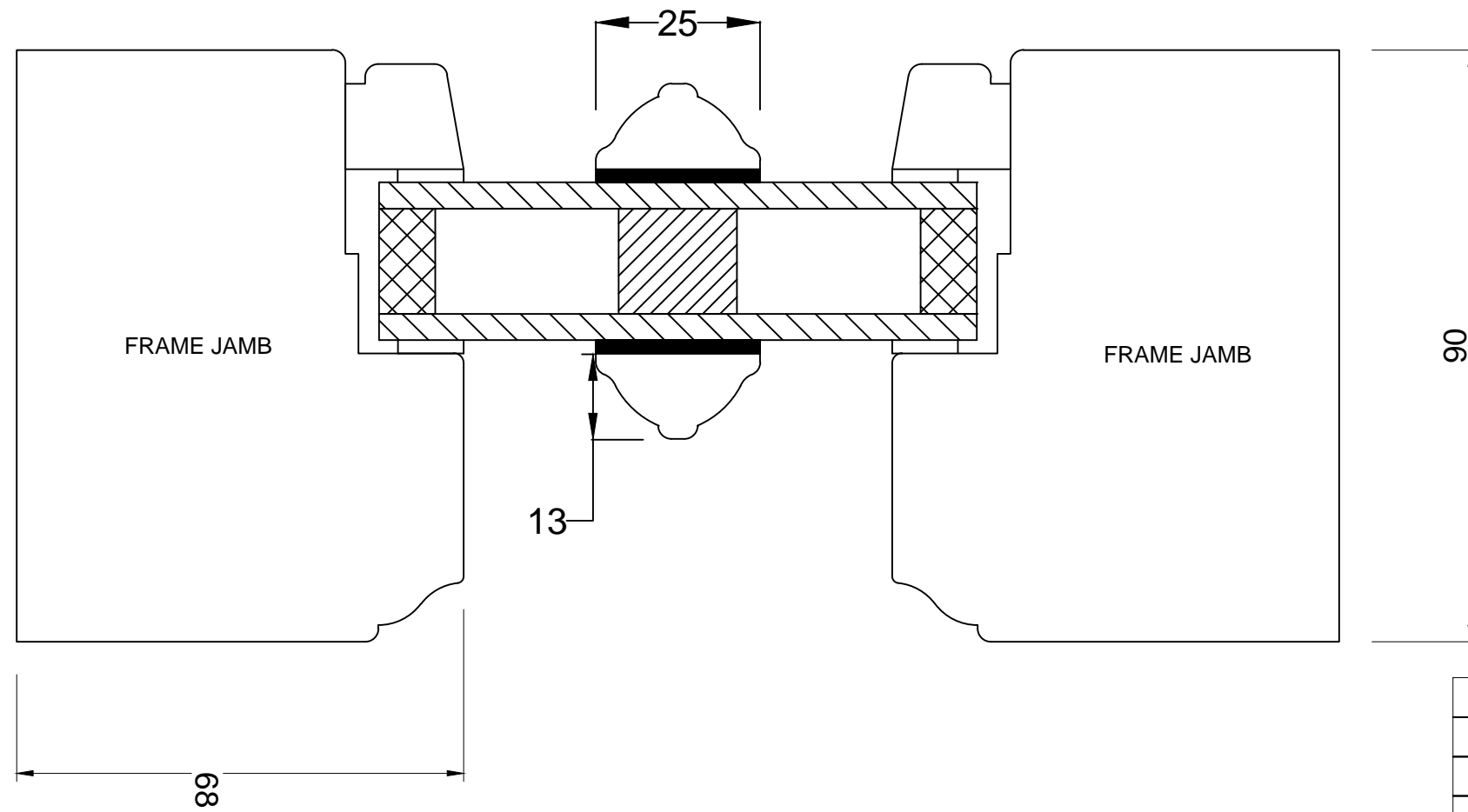

|          | BY | DATE |
|----------|----|------|
| DRAWN    |    |      |
| CHECKED  |    |      |
| APPROVED |    |      |



**ERW Joinery Ltd**  
Skippers Lane, Skippers  
Lane Industrial Estate,  
Middlesbrough, TS6 6HA  
Tel: 01642 456167 Fax:  
01642 462708 Email:  
info@erw ltd.co.uk  
www.erw ltd.co.uk

DESCRIPTION  
90MM CASEMENT WINDOW, DIRECT GLAZED  
HORIZONTAL SECTION

|            |     |             |
|------------|-----|-------------|
| SCALE      | 1:1 | DRAWING N°  |
| PAPER SIZE | A3  | ERW/350/001 |

NYMNP

24/09/2018

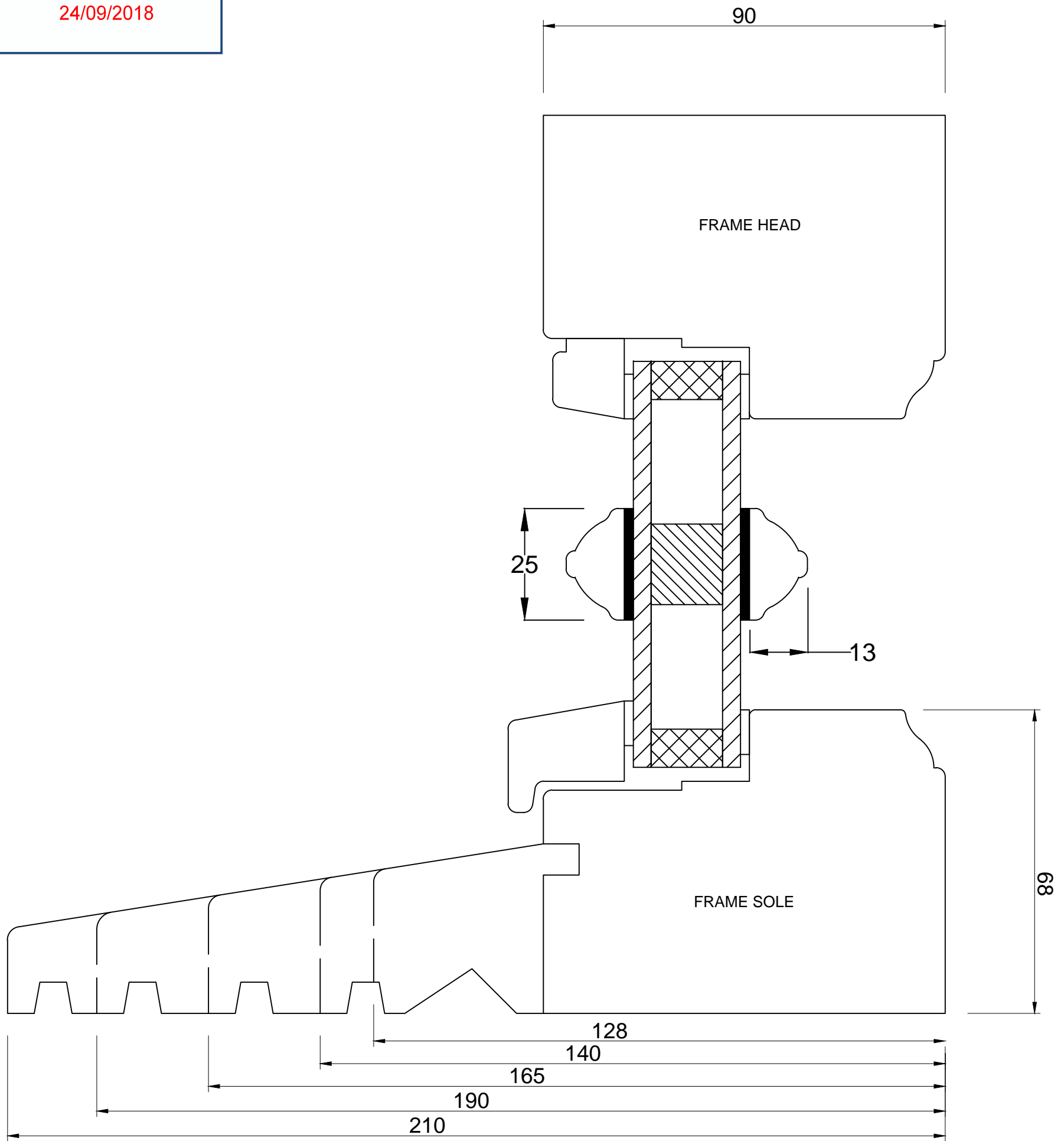

|  |     |             |
|--|-----|-------------|
|  | BY  | DATE        |
| DRAWN  |     |             |
| CHECKED  |     |             |
| APPROVED   |     |             |
| <p><b>ERW Joinery Ltd</b><br/>                 Skippers Lane, Skippers Lane Industrial Estate,<br/>                 Middlesbrough, TS6 6HA<br/>                 Tel: 01642 456167 Fax: 01642 462708 Email: info@erw ltd.co.uk<br/>                 www.erw ltd.co.uk</p> |     |             |
| <p>DESCRIPTION<br/>                 90MM CASEMENT WINDOW DIRECT GLAZED VERTICAL SECTION</p>  |     |             |
| SCALE  | 1:1 | DRAWING N°  |
| PAPER SIZE   | A3  | ERW/350/003 |

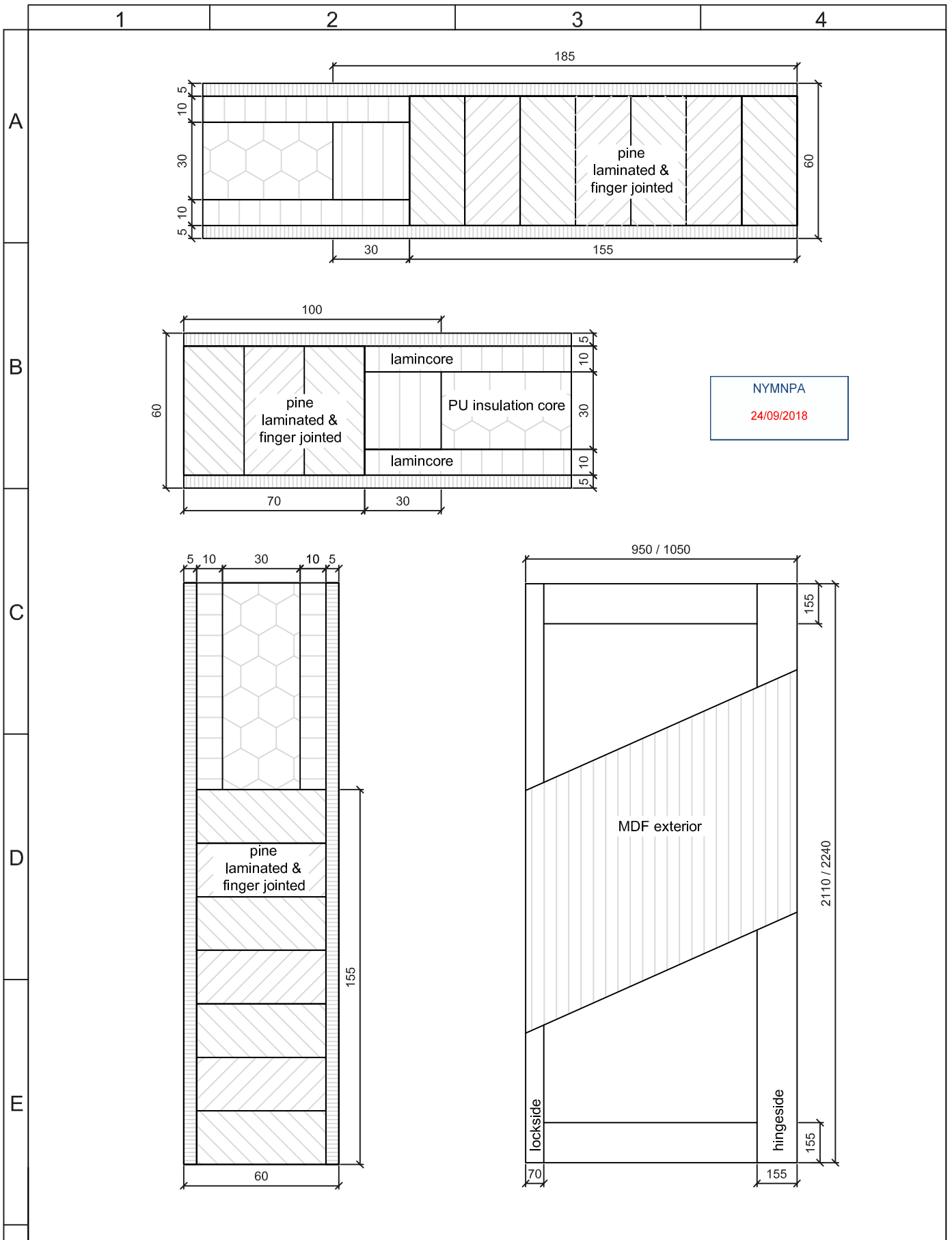

|   |          |          |   |     |      |
|---|----------|----------|---|-----|------|
|   | Datum    | Name     | scale   | 1:2 | 1:20 |
| drawn   | 28.10.15 | DREER    | <b>Moralt LAMINESSE</b><br><b>Klima2 PU</b><br><br>u-value 1,1 - 0,85* W/m <sup>2</sup> K<br>*when cut to minimum door size |     |      |
| checked   | 28.10.15 | DASCHNER |   |     |      |
| MT-MV-DB-003-06   |          |          |   |     |      |
| REV.04  |          |          |   |     |      |
|  |          |          |   |     |      |

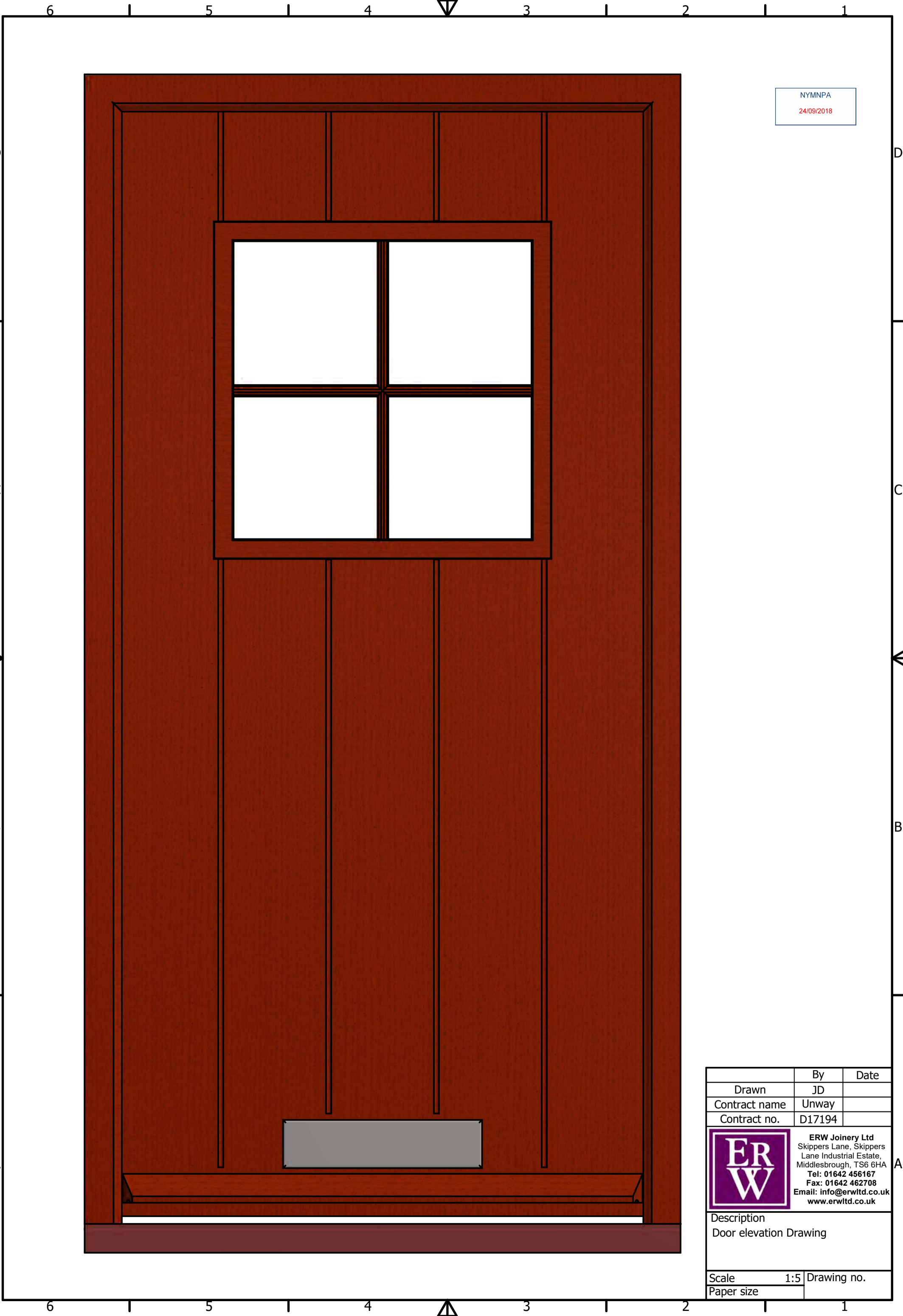

NYMNP A  
24/09/2018

|   |  |      |
|---|--|------|
|   | By   | Date |
| Drawn   | JD   |      |
| Contract name   | Unway  |      |
| Contract no.  | D17194   |      |
|  | <b>ERW Joinery Ltd</b><br>Skippers Lane, Skippers Lane Industrial Estate, Middlesbrough, TS6 6HA<br>Tel: 01642 456167<br>Fax: 01642 462708<br>Email: info@erw ltd.co.uk<br>www.erw ltd.co.uk |      |
|   | Description  |      |
|   | Door elevation Drawing   |      |
|   | Scale  | 1:5  |
| Paper size  |  |      |



NYMNPA

24/09/2018

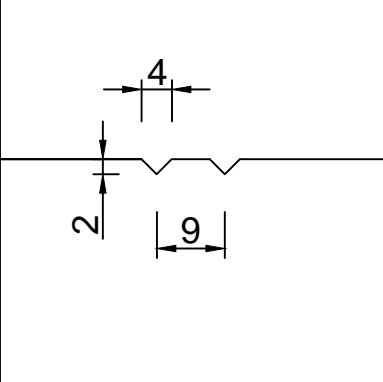
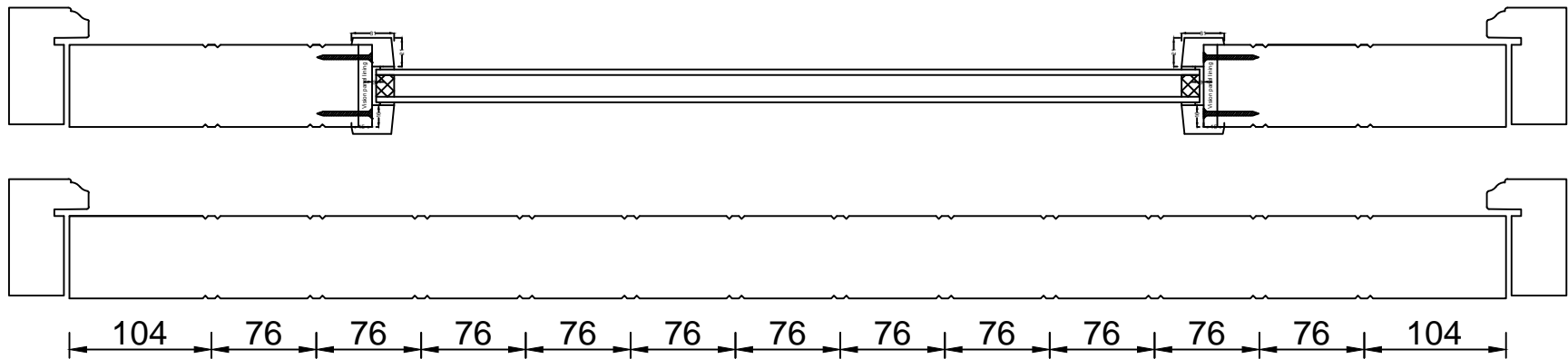

**ERW Joinery Ltd**  
 Skippers Lane, Skippers Lane Industrial Estate, Middlesbrough, TS6 6HA  
 Tel: 01642 456167 Fax: 01642 462708 Email: info@erw ltd.co.uk  
 www.erw ltd.co.uk

|               | BY     | DATE | DESCRIPTION                       |     |            |
|---------------|--------|------|-----------------------------------|-----|------------|
| DRAWN         | JD     | -    | FRONT ENTRANCE HORIZONTAL SECTION |     |            |
| CONTRACT REF. | PAUL   | -    |                                   |     |            |
| CONTRACT NO.  | D18052 | -    |                                   |     |            |
| CHECKED       | -      | -    | SCALE                             | 1:5 | DRAWING N° |
| APPROVED      | -      | -    | PAPER SIZE                        | A4  | REV        |
|               |        |      |                                   |     | 0          |