









-  Retention Category A
-  Retention Category B
-  Retention Category C
-  Retention Category R
-  Root Protection area (RPA)
-  Tree protection fence (To be adjusted as works progress.)

Tree Survey to BS 5837:2005.  
Trees in relation to construction -  
Recommendations

NYMNPA  
27 OCT 2008

**TREE PROTECTION FENCE DETAIL**

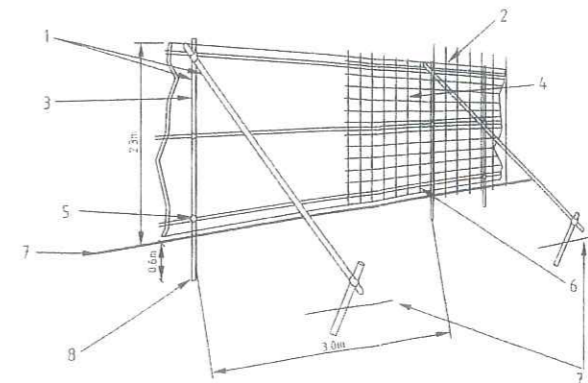

- 1 Standard scaffold poles
- 2 Uprights to be driven into the ground
- 3 Panels secured to uprights with wire ties and where necessary standard scaffold clamps
- 4 Weldmesh wired to the uprights and horizontals
- 5 Standard clamps
- 6 Wire twisted and attached on inside face of fencing to avoid any dismounting
- 7 Ground level
- 8 Approx. 9.6 m driven into the ground



**SMEEDEN FOREMAN**

Address: Ralshwaite Hall  
Title: Arboricultural survey  
Scale: 1:400 @ A0 - A5  
Date: Oct 07  
Drawing No: SFP 1249 Drawing Title: S01