

APPLICATION FOR APPROVAL OF DETAILS RESERVED BY CONDITION – 20<sup>th</sup> Feb 2015  
High Street, Egton – Decision No. NYM/2013/0297/FL

CONDITION	INFORMATION SUBMITTED	STATUS
Condition Four	ASD Lighting Clarity with Photocell. Please refer to ASD clarity product information.	
Condition Ten	Clay Pantile – Sandtoft Old England Non Interlocking Pantile      Slate – Natural Slate Cupa H12 450mm x 224mm	
Condition Eleven	Please refer to AWSM window & door details & Allan Brothers order information. RAL colours: Black 9005, Blue 5003, Green 6005, White 9016 (standard Allan Brothers colour)	
Condition Fourteen	Please refer to AWSM window & door details & Allan Brothers order information.	
Condition Eighteen	External lighting as condition 4. Meter Boxes – Smart meter boxes used with no external meter box. Flues – No external boiler flues. Acel Stone Colour Extract flue grilles. Tile Vents – Standard tile vents to be fitted Aerials & Satellite Dishes – None present.	
Condition Twenty Three	Please refer to renewable energy statement.	

NYMNPA  
23 FEB 2015

NYM / 2013 / 0297 / FL

# CLARITY RANGE

IP65

A robust high performance exterior luminaire.

NYMNPANYM / 2015 / 0120 / CVG  
23 FEB 2015

Clarity – The stunning collection of exterior luminaires from ASD Lighting – a truly comprehensive range offering a dazzling array of styles, colours, finishes, configurations, sensors and lamp options to suit a wide range of applications. The Clarity brings together all the best design and installation features found in ASD products with one clear vision; to deliver a distinctive and precision-engineered range that is stylish, eye-catching and bold.

Available with BC/ES lamp holders, CFL and LED versions.

- Portrait or Landscape mountable.
- Louvre, Eyelid, Cage or Plain Ring trims.
- Range of lamp and control gear options.
- Switch start or High Frequency.
- Energy saving options include lamp.
- LED options.
- Diffuser available in opal and fresnel prismatic.
- Fast fit base and gearray.
- Single screw fixing front trims.
- Interchangeable trims.
- Secure, IP rated diffuser.
- Photocell option.
- PIR option.

## Colour finish options

White  
(W)



Black  
(B)



Titanium  
(X)

Clarity Landscape  
Black Plain

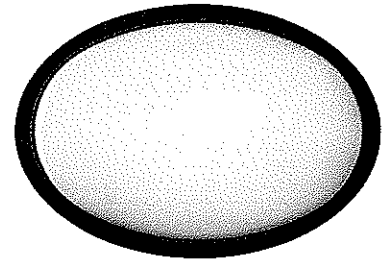

Clarity Portrait  
White Eyelid

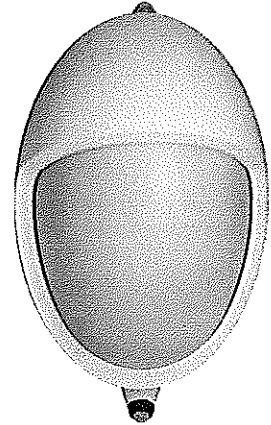

Clarity Landscape  
Black Cage

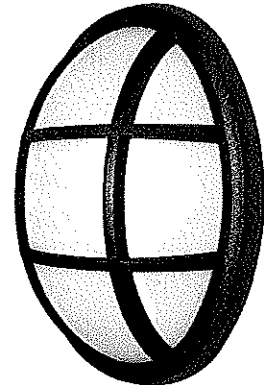

Clarity Landscape  
White louvre

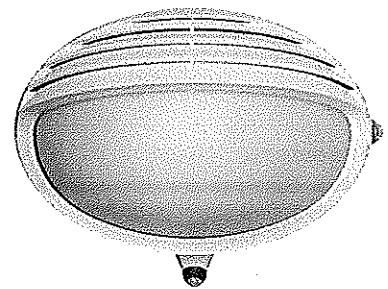

### Lamp Types

- 60W BC G15 (lamp not included).
- 1 and 2 x 9W 2-Pin G23 Cap.
- 1 x 18W TC-D G24q-2.
- PLEASE NOTE – 60W E27 G15 (lamp not included) also available.
- LED 3.
- LED 5.

### Materials

- Body: Landscape/portrait orientation in vandal resistant polycarbonate self-extinguishing fire properties in black / white / titanium. (plus halo backlight options).
- Fascia Ring: Vandal resistant polycarbonate with self-extinguishing fire properties.
- Diffuser: Vandal resistant polycarbonate clear/opal fresnel lens with self-extinguishing fire properties.

### Installation

- Wall or ceiling mount.
- BESA fixing and rear cable entry. 3 way mains terminal block. 4 way terminal block for high frequency photocell version.
- Auto level Feature.
- Hinged front fascia retained by single screw.
- Screw down diffuser.
- Photocell version - external use only.
- 2 x Conduit entry points.

### Standards

- IP65.
- 'F' Mark.
- CE.
- BS EN 60598.
- Class 1.

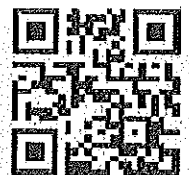

# CLARITY LANDSCAPE

C2L

NYM : 2015 / 0129 / CVC

Based on a C2L/BCPLED5

NYMNP  
23 FEB 2015  
Landscape

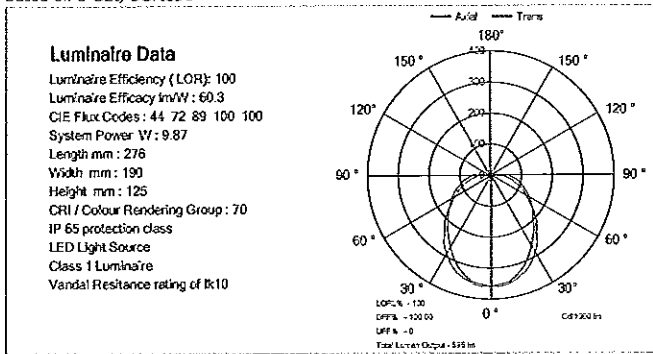
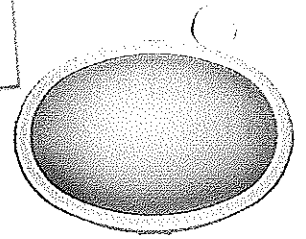

**Options** Add suffix to codes:  
**P** PIR  
**C** Photocell  
**E** High frequency  
**U** 60W E27  
**CAGE** C2L/BLP to C2L/BIC  
**EYELID** C2L/BLP to C2L/BLE  
**LOUVRE** C2L/BLP to C2L/BLL

**FRESNEL** C2L/BL to C2L/BK  
**DIFFUSER**

Other options or configurations may be available, please contact us on 01709 374898 or email sales@asdlighting.com for advice.

Product	Switch Start	High Frequency	3 Hour Maintained	Photocell	PIR	Dimmable	Night Light	Self Test
60W				■	■			
9W	■	■		■	■			
2 X 9W	■	■		■	■			
18W	■	■		■	■			
LED 3				■	■			
LED 5				■	■			

## Clarity Plain Landscape

Description	60W	60W PC	60W PIR	9W	9W PC	9W PIR	2 X 9W	2 X 9W PC	2 X 9W PIR
Black Opal	C2L/BLP060	C2L/BLP060C	C2L/BLP060P	C2L/BLP009	C2L/BLP009C	C2L/BLP009P	C2L/BLP2X9	C2L/BLP2X9C	C2L/BLP2X9P
White Opal	C2L/WLP060	C2L/WLP060C	C2L/WLP060P	C2L/WLP009	C2L/WLP009C	C2L/WLP009P	C2L/WLP2X9	C2L/WLP2X9C	C2L/WLP2X9P
Titanium Opal	C2L/XLP060	C2L/XLP060C	C2L/XLP060P	C2L/XLP009	C2L/XLP009C	C2L/XLP009P	C2L/XLP2X9	C2L/XLP2X9C	C2L/XLP2X9P

Description	18W	18W PC	18W PIR	LED 3	LED 3 PC	LED 3 PIR	LED 5	LED 5 PC	LED 5 PIR
Black Opal	C2L/BLP118	C2L/BLP118C	C2L/BLP118P	C2L/BLPLED3	C2L/BLPLED3C	C2L/BLPLED3P	C2L/BLPLED5	C2L/BLPLED5C	C2L/BLPLED5P
White Opal	C2L/WLP118	C2L/WLP118C	C2L/WLP118P	C2L/WLPLED3	C2L/WLPLED3C	C2L/WLPLED3P	C2L/WLPLED5	C2L/WLPLED5C	C2L/WLPLED5P
Titanium Opal	C2L/XLP118	C2L/XLP118C	C2L/XLP118P	C2L/XLPLED3	C2L/XLPLED3C	C2L/XLPLED3P	C2L/XLPLED5	C2L/XLPLED5C	C2L/XLPLED5P

## Attachments

Description	Eyelid	Louvre	Cage
Black	C2L/BE	C2L/BL	C2L/BC
White	C2L/WE	C2L/WL	C2L/WC
Titanium	C2L/XE	C2L/XL	C2L/XC

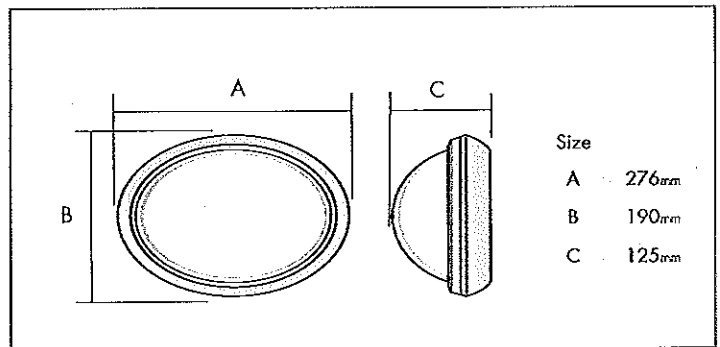

### Lamp Types

- 60W BC G15 (lamp not included).
- 1 and 2 x 9W 2-Pin G23 Cap.
- 1 x 18W TCD G24q2.
- PLEASE NOTE – 60W E27 G15 (lamp not included) also available.
- LED 3.
- LED 5.

### Materials

- Body: Landscape/portrait orientation in vandal resistant polycarbonate self-extinguishing fire properties in black / white / titanium. (plus halo backlight options).
- Fascia Ring: Vandal resistant polycarbonate with self-extinguishing fire properties.
- Diffuser: Vandal resistant polycarbonate clear/opal fresnel lens with self-extinguishing fire properties.

### Installation

- Wall or ceiling mount.
- BESA fixing and rear cable entry. 3 way mains terminal block. 4 way terminal block for high frequency photocell version.
- Auto level feature.
- Hinged front fascia retained by single screw.
- Screw down diffuser.
- Photocell version - external use only.
- 2 x Conduit entry points

### Standards

- IP65.
- 'F' Mark.
- CE.
- BS EN 60598.
- Class 1.

# CLARITY PORTRAIT

C2P

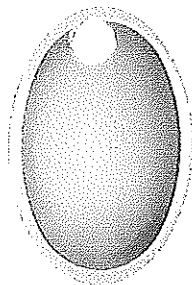

Portrait

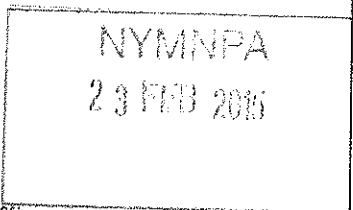

Based on a C2P/BCPLED5

### Luminaire Data

Luminaire Efficiency (LOR): 100  
 Luminaire Efficacy lm/W: 60.3  
 CIE Flux Codes: 44 72 89 100 100  
 System Power W: 9.87  
 Length mm: 276  
 Width mm: 190  
 Height mm: 125  
 CRI / Colour Rendering Group: 70  
 IP 65 protection class  
 LED Light Source  
 Class 1 Luminaire  
 Vandal Resistance rating of IK10

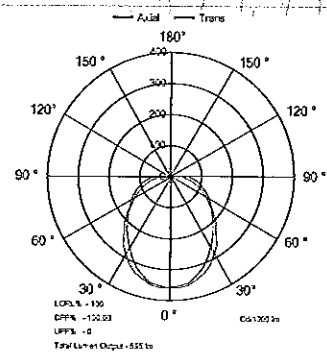

- Options Add suffix to codes:
- P PIR
  - C Photocell
  - E High frequency
  - U 60W E27
  - CAGE C2P/BLP to C2P/BLC
  - EYELID C2P/BLP to C2P/BLE
  - LOUVRE C2P/BLP to C2P/BLL

FRESNEL C2P/BL to C2P/BK  
 DIFFUSER

Other options or configurations may be available, please contact us on 01709 374898 or email sales@asdlighting.com for advice.

Product	Switch Start	High Frequency	3 Hour Maintenance	Photocell	PIR	Dimmable	Height Light	Self Test
60W				■	■			
9W	■	■		■	■			
2 X 9W	■	■		■	■			
18W	■	■		■	■			
LED 3				■	■			
LED 5				■	■			

## Clarity Plain Portrait

Description	60W	60W PC	60W PIR	9W	9W PC	9W PIR	2 X 9W	2 X 9W PC	2 X 9W PIR
Black Opal	C2P/BLP060	C2P/BLP060C	C2P/BLP060P	C2P/BLP009	C2P/BLP009C	C2P/BLP009P	C2P/BLP2X9	C2P/BLP2X9C	C2P/BLP2X9P
White Opal	C2P/WLP060	C2P/WLP060C	C2P/WLP060P	C2P/WLP009	C2P/WLP009C	C2P/WLP009P	C2P/WLP2X9	C2P/WLP2X9C	C2P/WLP2X9P
Titanium Opal	C2P/XLP060	C2P/XLP060C	C2P/XLP060P	C2P/XLP009	C2P/XLP009C	C2P/XLP009P	C2P/XLP2X9	C2P/XLP2X9C	C2P/XLP2X9P

Description	18W	18W PC	18W PIR	LED 3	LED 3 PC	LED 3 PIR	LED 5	LED 5 PC	LED 5 PIR
Black Opal	C2P/BLP118	C2P/BLP118C	C2P/BLP118P	C2P/BLPLED3	C2P/BLPLED3C	C2P/BLPLED3P	C2P/BLPLED5	C2P/BLPLED5C	C2P/BLPLED5P
White Opal	C2P/WLP118	C2P/WLP118C	C2P/WLP118P	C2P/WLPLED3	C2P/WLPLED3C	C2P/WLPLED3P	C2P/WLPLED5	C2P/WLPLED5C	C2P/WLPLED5P
Titanium Opal	C2P/XLP118	C2P/XLP118C	C2P/XLP118P	C2P/XLPLED3	C2P/XLPLED3C	C2P/XLPLED3P	C2P/XLPLED5	C2P/XLPLED5C	C2P/XLPLED5P

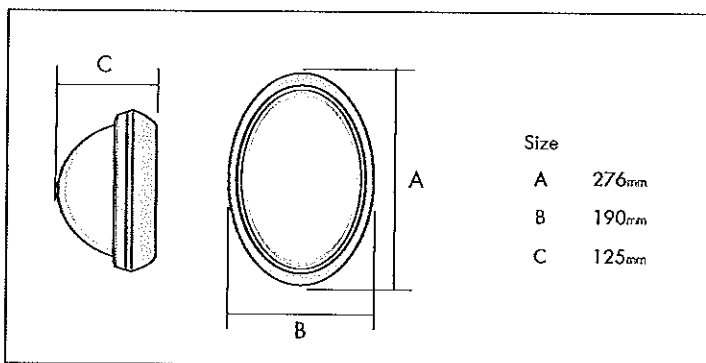

Size  
 A 276mm  
 B 190mm  
 C 125mm

### Attachments

Description	Eyelid	Louvre	Cage
Black	C2P/BE	C2P/BL	C2L/BC
White	C2P/WE	C2P/WL	C2L/WC
Titanium	C2P/XE	C2P/XL	C2L/XC

### Lamp Types

- 60W BC GLS (lamp not included).
- 1 and 2 x 9W 2-Pin G23 Cap.
- 1 x 18W TC-D G24q-2.
- PLEASE NOTE – 60W E27 GLS (lamp not included) also available.
- LED 3.
- LED 5.

### Materials

- Body: landscape/portrait orientation in vandal resistant polycarbonate self-extinguishing fire properties in black / white / titanium. (plus halo backlight options).
- Fascia Ring: Vandal resistant polycarbonate with self-extinguishing fire properties.
- Diffuser: Vandal resistant polycarbonate clear/opal fresnel lens with self extinguishing fire properties.

### Installation

- Wall or ceiling mount.
- BESA fixing and rear cable entry. 3 way mains terminal block. 4 way terminal block for high frequency photocell version.
- Auto level feature.
- Hinged front fascia retained by single screw.
- Screw down diffuser.
- Photocell version - external use only.
- 2 x Conduit entry points.

### Standards

- IP65.
- 'F' Mark.
- CE.
- BS EN 60598.
- Class I.





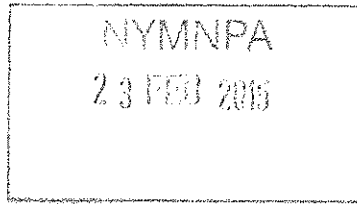

High Street, Egton

Renewable Energy Measures

### Introduction

The development at High Street, Egton consists of 10 dwellings which are to be constructed to Code for Sustainable Homes Level 3 & comply with Part L 2010.

### Planning Requirements

The local planning authority, North York Moors National Park Authority has placed the following condition on the scheme.

#### Condition 23:-

The development hereby permitted shall not be brought into use until the approved renewable energy measures to generate energy on site from renewable sources to displace at least 10% of predicted CO<sub>2</sub> emissions have been installed and thereafter maintained in a working condition.

The purpose of this document is to demonstrate that at least 10% of energy used on the scheme is coming from renewable sources.

### Proposals

The development is situated in a small rural village within the North York Moors National Park which does not have a connection to the mains gas grid. With this in mind the decision has been taken to utilise renewable technology to provide water & space heating in the form of an Air Source Heat Pump.

Each dwelling will have a Vaillant Arotherm 5kw Heat Pump along with a Vaillant 200ltr Heat Pump Cylinder.

### Anticipated Annual Energy Demand

Standard Assessment Procedure (SAP) calculations have been carried out by a suitably qualified person to determine the anticipated total annual energy demand for lighting, electrical equipment and water / space heating.

#### Energy Demand (kg CO<sub>2</sub>/yr):

Plot 1 – 2094.98  
Plot 2 – 1943.13  
Plot 3 – 1943.13  
Plot 4 – 1939.1  
Plot 5 – 1943.07  
Plot 6 – 1943.07  
Plot 7 – 2094.98  
Plot 8 – 1832.76  
Plot 9 – 2099.89  
Plot 10 – 2523.16  
Total – 20357.27



Air Source Heat Pump Input (kg CO<sub>2</sub>/yr)

Plot 1 – 1558.65  
Plot 2 – 1406.80  
Plot 3 – 1406.80  
Plot 4 – 1402.77  
Plot 5 – 1406.74  
Plot 6 – 1406.74  
Plot 7 – 1558.65  
Plot 8 – 1345.93  
Plot 9 – 1571.56  
Plot 10 – 1942.06  
Total – 15006.7

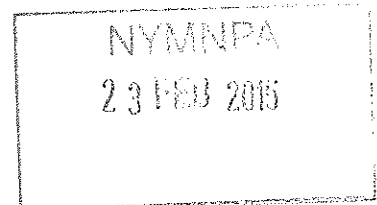

Contribution

Plot 1 – 74%  
Plot 2 – 72%  
Plot 3 – 72%  
Plot 4 – 72%  
Plot 5 – 72%  
Plot 6 – 72%  
Plot 7 – 74%  
Plot 8 – 73%  
Plot 9 – 74%  
Plot 10 – 76%  
Total – 73%

Conclusion

The total contribution from renewable technology is 73% which exceeds the planning requirement of 10%

The calculations take into account energy use within each house and have not taken in any energy consumed within the development i.e street lighting etc.

NYM / 2015 / 0000000000000000

**PURCHASE ORDER**

Allan Brothers Ltd  
 Allan House  
 Ord Road  
 Tweedmouth  
 Berwick Upon Tweed  
 Northumbria

NYMNP  
 23 FEB 2015

Please deliver to:  
 SEE BELOW FOR ADDRESS  
 ENSURE THAT PO NUMBER IS QUOTED ON INVOICES, IF NOT  
 INVOICE WILL BE REJECTED  
 AND PAYMENT DELAYED. THIS  
 ORDER IS ISSUED IN ACCORDANCE  
 WITH OUR

<b>Your Ref</b> STUART GILLESPIE	<b>Account</b> ALL031	<b>Our Ref</b> 67174	<b>Delivery</b>	<b>Type</b> POP Page: 1	<b>Date</b> 11/11/2014	<b>Required</b> 15/12/2014
-------------------------------------	--------------------------	-------------------------	-----------------	----------------------------	---------------------------	-------------------------------

<b>Description</b>	<b>Quantity</b>	<b>Required</b>
FOR THE SUPPLY AND DELIVERY OF THE FOLLOWING TO;		15/12/2014

THE REAR OF BROWNS WOOD  
 COTTAGES,  
 OFF HIGH STREET  
 EGTON  
 NORTH YORKS  
 YO21 1TX

SITE REF; 110260  
 SITE MANAGER; ANDY SMITH 07768  
 476 863

EXTERNAL DOORS AND WINDOWS AS PER ALLAN BROS QUOTATION AND ORDER NUMBER 521598-1-4;		15/12/2014
---	--	------------

PLOTS 1 - 7 INCL	1.00	15/12/2014
------------------	------	------------

PLOTS 8 - 10 INCL	1.00	16/01/2015
-------------------	------	------------

DELIVERY IN TWO ARTICULATED LORRY LOADS INCLUDED; PLOTS 1 - 7 W/C 15/12/14 PLOTS 8 - 10 BY 18/01/15. SITE OFF LOADING.		15/12/2014
--	--	------------

CONFIRMATION TO STUART GILLESPIE 01289 334 640		15/12/2014
---	--	------------

(BDM; STEPHEN KIDD 07866 855369).



NEW / REPLACEMENT ORDER SIGN-OFF



10/11/2014 / 10/11/2014 / C.V.C

NYMNP  
23 FEB 2015

Customer Strategic Team Group Ltd  
AB Order No. 521598-3  
Date 10/11/2014

Customer Reference: Ref: Egton Timber Windows  
Customer Contact: Frank  
Project Coordinator Stuart Gillespie

IMPORTANT: PLEASE REVIEW THE ENCLOSED DOCUMENTS

The enclosed documents have been prepared to the specification for manufacture of this contract. To process your order to manufacture please review, acknowledge and confirm by signing below the full detail and final price to be correct.

We the customer confirm we wish to proceed with the enclosed Specification documents which are correct, and to our requirements, WITH;

(Please Indicate In one box below (a) -or- (b) - as applicable)

(a)  NO Amendments \* (b)  further Amendments \*\*

\*\* [please indicated specific amendment/s required by over-writing adjacent to each applicable item on the attached documents]

For and on Behalf of: STRATEGIC TEAM GROUP Position: REGIONAL BUYER

Sign: [Signature] Date: 10/11/14

Price sign-off: (only sign this section if option A above has been signed off)  
Allan Brothers confirm the ex-works price, excluding VAT for the above contract:

We the Customer confirm our acceptance of this Final Price, in regard to the above Contract and wish to:-

(Please Indicate in one box below (a) -or- (b) - as applicable)

(a)  Accept Delivery as separately detailed (b)  Decline Delivery  
(£0)

For and on Behalf of: STRATEGIC TEAM GROUP Position: REGIONAL BUYER

Sign: ... Date: 10/11/14

Purchase order sign-off:

We the customer confirm that our purchase order (see above) will cover the final amount of this contract:

Yes  No (delete as appropriate)

If no. listed below is our replacement purchase order number, or our additional purchase order number:

New P/O.....

Additional P/O.....

Please note

All efforts have been made to ensure that the product specifications are correct to the customer's requirements; however it is the customer's sole responsibility to check the specifications are correct to their requirements.

Allan Brothers accept no liability for products manufactured to the signed-off specification.

PLEASE FAX COMPLETED SHEET BACK TO

# Order ref no. 521598-3 Summary

NYM / 2015 / 0 / 1 / 2 / 0 / 7 / C / V / C

Item	Reference	Overall Size	Qty	Unit Price	Total Price
1	P1W1	670 x 1045mm	1		
2	P1W2	670 x 1045mm	1		
3	P1W7A	616 x 1270mm	2		
4	P1W7B	616 x 1270mm	2		
5	P1W7 Joint Pack	Length: 1270mm	2		
6	P1W9A	616 x 1345mm	1		
7	P1W9B	616 x 1345mm	1		
8	P1W9 Joint Pack	Length: 1345mm	1		
9	P1W11A	791 x 1045mm	1		
10	P1W11B	791 x 1045mm	1		
11	P1D2	1007 x 2095mm	1		
12	P1D7	1007 x 2095mm	1		
13	P2W1	670 x 1045mm	1		
14	P2W2	670 x 1045mm	1		
15	P2W7A	616 x 1270mm	2		
16	P2W7B	616 x 1270mm	2		
17	P2W7 Joint Pack	Length: 1270mm	2		
18	P2W9A	616 x 1345mm	1		
19	P2W9B	616 x 1345mm	1		
20	P2W9 Joint Pack	Length: 1345mm	1		
21	P2W11A	791 x 1045mm	1		
22	P2W11B	791 x 1045mm	1		
23	P2D1	1007 x 2095mm	1		
24	P2D8	1007 x 2095mm	1		
25	P3W3	670 x 1045mm	1		
26	P3W4	670 x 1045mm	1		
27	P3W8	1232 x 1270mm	2		
28	P3W10	1232 x 1345mm	1		
29	P3W12A	841 x 1045mm	1		
30	P3W12B	841 x 1045mm	1		
31	P3W12 Joint Pack	Length: 1045mm	1		
32	P3D4	1007 x 2095mm	1		
33	P3D7	1007 x 2095mm	1		
34	P4W3	670 x 1045mm	1		
35	P4W4	670 x 1045mm	1		
36	P4W8	1232 x 1270mm	2		
37	P4W10	1232 x 1345mm	1		
38	P4W12A	841 x 1045mm	1		
39	P4W12B	841 x 1045mm	1		

NYMNPA  
23 FEB 2015

40	P4W12 Joint Pack	Length: 1045mm	1
41	P4D3	1007 x 2095mm	1
42	P4D8	1007 x 2095mm	1
43	P5W3	670 x 1045mm	1
44	P5W4	670 x 1045mm	1
45	P5W8	1232 x 1270mm	2
46	P5W10	1232 x 1345mm	1
47	P5W12A	841 x 1045mm	1
48	P5W12B	841 x 1045mm	1
49	P5W12 Joint Pack	Length: 1045mm	1
50	P5D2	1007 x 2095mm	1
51	P5D7	1007 x 2095mm	1
52	P6W1	670 x 1045mm	1
53	P6W2	670 x 1045mm	1
54	P6W7A	616 x 1270mm	2
55	P6W7B	616 x 1270mm	2
56	P6W7 Joint Pack	Length: 1270mm	2
57	P6W9A	616 x 1345mm	1
58	P6W9B	616 x 1345mm	1
59	P6W9 Joint Pack	Length: 1345mm	1
60	P6W11A	791 x 1045mm	1
61	P6W11B	791 x 1045mm	1
62	P6D6	1007 x 2095mm	1
63	P6D7	1007 x 2095mm	1
64	P7W1	670 x 1045mm	1
65	P7W2	670 x 1045mm	1
66	P7W7A	616 x 1270mm	2
67	P7W7B	616 x 1270mm	2
68	P7W7 Joint Pack	Length: 1270mm	2
69	P7W9A	616 x 1345mm	1
70	P7W9B	616 x 1345mm	1
71	P7W9 Joint Pack	Length: 1345mm	1
72	P7W11A	791 x 1045mm	1
73	P7W11B	791 x 1045mm	1
74	P7D5	1007 x 2095mm	1
75	P7D8	1007 x 2095mm	1
76	P8W1	670 x 1045mm	2
77	P8W2	670 x 1045mm	1
78	P8W6A	616 x 1045mm	1
79	P8W6B	616 x 1045mm	1
80	P8W6 Joint Pack	Length: 1045mm	1
81	P8W7A	616 x 1270mm	2
82	P8W7B	616 x 1270mm	2
83	P8W7 Joint Pack	Length: 1270mm	2

NYMNPA  
23 FEB 2015

84	P8D7	1007 x 2095mm	1	
85	P9W1	670 x 1045mm	1	
86	P9W6A	616 x 1045mm	2	
87	P9W6B	616 x 1045mm	2	
88	P9W6 Joint Pack	Length: 1045mm	2	
89	P9W7A	616 x 1270mm	2	
90	P9W7B	616 x 1270mm	2	
91	P9W7 Joint Pack	Length: 1270mm	2	
92	P9D7	1007 x 2095mm	1	
93	P10W1	670 x 1045mm	1	
94	P10W2	670 x 1045mm	1	
95	P10W5	670 x 1270mm	1	
96	P10W6A	616 x 1045mm	1	
97	P10W6B	616 x 1045mm	1	
98	P10W6 Joint Pack	Length: 1045mm	1	
99	P10W7A	616 x 1270mm	1	
100	P10W7A (Vent)	616 x 1270mm	3	
101	P10W7B	616 x 1270mm	4	
102	P10W7 Joint Pack	Length: 1270mm	4	
103	P10W9A	616 x 1345mm	3	
104	P10W9B	616 x 1345mm	3	
105	P10W9 Joint Pack	Length: 1345mm	3	
106	P10D1	1007 x 2095mm	1	
107	P10D7	1007 x 2095mm	1	
108	1350mm Loose Cills	Length: 1350mm	27	
109	1700mm Loose Cills	Length: 1700mm	7	
110	W11 Cover Facings	Length: 1045mm	4	
111	P10W1 (SBD)	670 x 1045mm	1	
		TOTAL	185	

AMANDA  
23 FEB 2015

185

Total Exc. VAT.

Delivery.

Total + Delivery Exc. VAT.

Order ref no. 521598-3

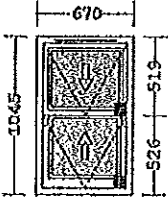
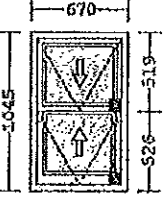
Line	Overall Size	Reference	Qty	Unit Price	Total
Line 1	670 x 1045mm	P1W1	1		
		Allan Brothers Slide & Tilt 145mm Profile Glazing - 4mm-20-4mm Soft Coat Low E Spacer - Black Swiss V Gas - Argon Glass Protective Film 2 Sides Glazing Beads - Redwood Hinge - Top and Bottom Sash S&T PAS24 White Spiral Tubes and Stoppers Sash Lock - White Security Sash Lock White hooklift White Tilt Latch Knobs & Conceal. Plate HN10 Horns Top Sash Only Sash Restrictor White x 1 Trickle Vent - TV90 425HL White (12) Weatherstrip - White Cill Board groove Cill Drip Groove Timber - Redwood Finger Jointed Laminate 62mm Cill Extension Colour - RAL 9016 Traffic white Individual Unit Weight 29.152kg			
Line 2	670 x 1045mm	P1W2	1		
		Allan Brothers Slide & Tilt 145mm Profile Glazing - 4mm-20-4mm Soft Coat Low E Spacer - Black Swiss V Gas - Argon Glass Protective Film 2 Sides Glazing Beads - Redwood Hinge - Top and Bottom Sash S&T PAS24 White Spiral Tubes and Stoppers Sash Lock - White Security Sash Lock White hooklift White Tilt Latch Knobs & Conceal. Plate HN10 Horns Top Sash Only Sash Restrictor White x 1 Weatherstrip - White Cill Board groove Cill Drip Groove Timber - Redwood Finger Jointed Laminate 62mm Cill Extension Stippolyte Obscure Colour - RAL 9016 Traffic white No vent Individual Unit Weight 29.152kg			

NYM/NPA  
23 FEB 2015

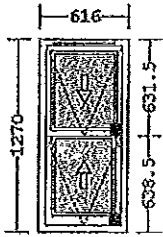
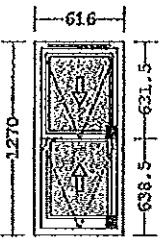
Line	Overall Size	Reference	Qty	Unit Price	Total
Line 3	616 x 1270mm	P1W7A	2		
		Allan Brothers Slide & Tilt 145mm Profile Glazing - 6.8mm Lam-18-4mm Tough Soft Coat Spacer - Black Swiss V Gas - Argon Glass Protective Film 2 Sides Glazing Beads - Redwood Hinge - Top and Bottom Sash S&T PAS24 White Spiral Tubes and Stoppers Sash Lock - White Security Sash Lock White hooklift White Tilt Latch Knobs & Conceal. Plate HN10 Horns Top Sash Only Sash Restrictor White x 1 Trickle Vent - TV90 425HL White (12) Weatherstrip - White Cill Board groove Cill Drip Groove Timber - Redwood Finger Jointed Laminate Colour - RAL 9016 Traffic white To be site coupled by others Individual Unit Weight 34.857kg			
Line 4	616 x 1270mm	P1W7B	2		
		Allan Brothers Slide & Tilt 145mm Profile Glazing - 6.8mm Lam-18-4mm Tough Soft Coat Spacer - Black Swiss V Gas - Argon Glass Protective Film 2 Sides Glazing Beads - Redwood Hinge - Top and Bottom Sash S&T PAS24 White Spiral Tubes and Stoppers Sash Lock - White Security Sash Lock White hooklift White Tilt Latch Knobs & Conceal. Plate HN10 Horns Top Sash Only Sash Restrictor White x 1 Trickle Vent - TV90 425HL White (12) Weatherstrip - White Cill Board groove Cill Drip Groove Timber - Redwood Finger Jointed Laminate Colour - RAL 9016 Traffic white To be site coupled by others Individual Unit Weight 34.857kg			
Line 5	Length: 1270mm	P1W7 Joint Pack	2		
		Item sent loose Timber - Redwood Finger Jointed Laminate 45mm Vertical Joint Pack Colour - RAL 9016 Traffic white			

NYMSPA  
 23/11/15 2015

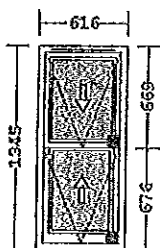
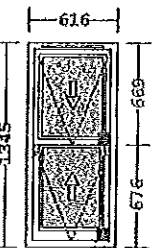
Line	Overall Size	Reference	Qty	Unit Price	Cost
Line 6	616 x 1345mm	P1W9A	1		
		Allan Brothers Slide & Tilt 145mm Profile Glazing - 6.8mm Lam-18-4mm Tough Soft Coat Spacer - Black Swiss V Gas - Argon Glass Protective Film 2 Sides Glazing Beads - Redwood Hinge - Top and Bottom Sash S&T PAS24 White Spiral Tubes and Stoppers Sash Lock - White Security Sash Lock White hooklift White Tilt Latch Knobs & Conceal. Plate HN10 Horns Top Sash Only Sash Restrictor White x 1 Trickle Vent - TV90 425HL White (12) Weatherstrip - White Cill Board groove Cill Drip Groove Timber - Redwood Finger Jointed Laminate Colour - RAL 9016 Traffic white To be site coupled by others Individual Unit Weight 36.531kg			
Line 7	616 x 1345mm	P1W9B	1		
		Allan Brothers Slide & Tilt 145mm Profile Glazing - 6.8mm Lam-18-4mm Tough Soft Coat Spacer - Black Swiss V Gas - Argon Glass Protective Film 2 Sides Glazing Beads - Redwood Hinge - Top and Bottom Sash S&T PAS24 White Spiral Tubes and Stoppers Sash Lock - White Security Sash Lock White hooklift White Tilt Latch Knobs & Conceal. Plate HN10 Horns Top Sash Only Sash Restrictor White x 1 Trickle Vent - TV90 425HL White (12) Weatherstrip - White Cill Board groove Cill Drip Groove Timber - Redwood Finger Jointed Laminate Colour - RAL 9016 Traffic white To be site coupled by others Individual Unit Weight 36.531kg			
Line 8	Length: 1345mm	P1W9 Joint Pack	1		
		Item sent loose Timber - Redwood Finger Jointed Laminate 45mm Vertical Joint Pack Colour - RAL 9016 Traffic white			

NYM/NPA  
23 FEB 2005

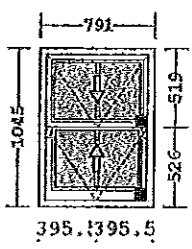
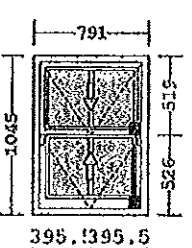
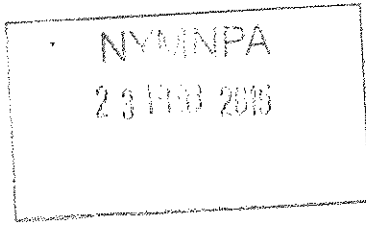
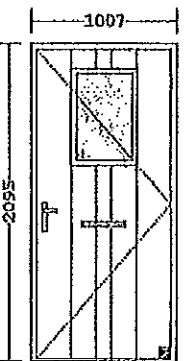
Line	Overall Size	Reference	Qty	Unit Price	Total
Line 9	791 x 1045mm	P1W11A	1		
		Allan Brothers Slide & Tilt 145mm Profile Glazing - 6.8mm Lam-18-4mm Tough Soft Coat Spacer - Black Swiss V Gas - Argon Glass Protective Film 2 Sides Glazing Beads - Redwood Hinge - Top and Bottom Sash S&T PAS24 White Spiral Tubes and Stoppers Sash Lock - White Security Sash Lock White hooklift White Tilt Latch Knobs & Conceal. Plate HN10 Horns Top Sash Only Sash Restrictor White x 1 Grilles - 25mm Bonded Bar + Swiss V Grilles Weatherstrip - White Cill Board groove Cill Drip Groove Timber - Redwood Finger Jointed Laminate Colour - RAL 9016 Traffic white No vent Individual Unit Weight 36.593kg			
Line 10	791 x 1045mm	P1W11B	1		
 		Allan Brothers Slide & Tilt 145mm Profile Glazing - 6.8mm Lam-18-4mm Tough Soft Coat Spacer - Black Swiss V Gas - Argon Glass Protective Film 2 Sides Glazing Beads - Redwood Hinge - Top and Bottom Sash S&T PAS24 White Spiral Tubes and Stoppers Sash Lock - White Security Sash Lock White hooklift White Tilt Latch Knobs & Conceal. Plate HN10 Horns Top Sash Only Sash Restrictor White x 1 Grilles - 25mm Bonded Bar + Swiss V Grilles Weatherstrip - White Cill Board groove Cill Drip Groove Timber - Redwood Finger Jointed Laminate Colour - RAL 9016 Traffic white No vent Individual Unit Weight 36.593kg			
Line 11	1007 x 2095mm	P1D2	1		
		Allan Brothers Scotdoor Clyde 92mm Profile Glazing - 6.8mm Soft Coat Low E Lam-18-4mm Tough Spacer - Black Swiss V Gas - Argon Glass Protective Film 2 Sides Standard pattern to outside and inside Hinge - Zinc Hinges RH Open In Handle - Polished Chrome ProSecure Handle Chrome Letterplate + Chrome Restrictor 48-38 Nickel Thumb Turn Cylinder Threshold - StormGuard AM3 Silver Weatherstrip - White Timber - Finger Jointed Laminate Frame Spyhole with extension - Chrome Security Chain Polished Chrome Stippolyte Obscure Colour - RAL 9016 Traffic white Individual Unit Weight 150.201kg			Plots 1, 2, 5, 10 Front Door

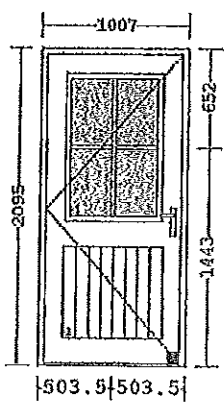
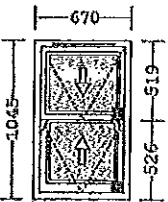
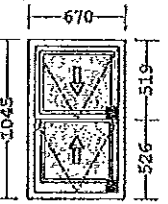

Order ref no. 521598-3

Line	Overall Size	Reference	Qty	Unit Price	Total
Line 12	1007 x 2095mm	P1D7	1		
		<p>Allan Brothers Scotdoor Dee 92mm Profile                      Glazing - 6.8mm Lam-18-4mm Tough Soft Coat                      Spacer - Black Swiss V                      Gas - Argon                      Glass Protective Film 2 Sides                      Standard pattern to outside and inside                      Hinge - Zinc Hinges                      LH Open In                      Handle - Polished Chrome ProSecure Handle                      48-38 Nickel Cylinder                      Grilles - 25mm Bonded Bar + Swiss V Grilles (11,-1)                      Threshold - StormGuard AM3 Silver                      Weatherstrip - White                      Timber - Finger Jointed Laminate Frame                      Colour - RAL 9016 Traffic white                      Individual Unit Weight 162.148kg</p>			All rear doors & Plot 9 First Floor Apartment Door
Line 13	670 x 1045mm	P2W1	1		
		<p>Allan Brothers Slide &amp; Tilt 145mm Profile                      Glazing - 4mm-20-4mm Soft Coat Low E                      Spacer - Black Swiss V                      Gas - Argon                      Glass Protective Film 2 Sides                      Glazing Beads - Redwood                      Hinge - Top and Bottom Sash S&amp;T PAS24                      White Spiral Tubes and Stoppers                      Sash Lock - White Security Sash Lock                      White hooklift                      White Tilt Latch Knobs &amp; Conceal. Plate                      HN10 Horns Top Sash Only                      Sash Restrictor White x 1                      Trickle Vent - TV90 425HL White (12)                      Weatherstrip - White                      Cill Board groove                      Cill Drip Groove                      Timber - Redwood Finger Jointed Laminate                      62mm Cill Extension                      Colour - RAL 9016 Traffic white                      Individual Unit Weight 29.152kg</p>			
Line 14	670 x 1045mm	P2W2	1		
		<p>Allan Brothers Slide &amp; Tilt 145mm Profile                      Glazing - 4mm-20-4mm Soft Coat Low E                      Spacer - Black Swiss V                      Gas - Argon                      Glass Protective Film 2 Sides                      Glazing Beads - Redwood                      Hinge - Top and Bottom Sash S&amp;T PAS24                      White Spiral Tubes and Stoppers                      Sash Lock - White Security Sash Lock                      White hooklift                      White Tilt Latch Knobs &amp; Conceal. Plate                      HN10 Horns Top Sash Only                      Sash Restrictor White x 1                      Weatherstrip - White                      Cill Board groove                      Cill Drip Groove                      Timber - Redwood Finger Jointed Laminate                      62mm Cill Extension                      Stipolyte Obscure                      Colour - RAL 9016 Traffic white                      No vent                      Individual Unit Weight 29.152kg</p>			

NYM/MPA  
23 FEB 2015

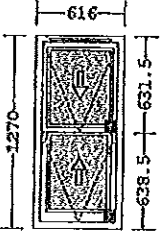
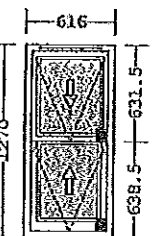
Line	Overall Size	Reference	Qty	Unit Price	Total
Line 15	616 x 1270mm	P2W7A	2		1
		Allan Brothers Slide & Tilt 145mm Profile Glazing - 6.8mm Lam-18-4mm Tough Soft Coat Spacer - Black Swiss V Gas - Argon Glass Protective Film 2 Sides Glazing Beads - Redwood Hinge - Top and Bottom Sash S&T PAS24 White Spiral Tubes and Stoppers Sash Lock - White Security Sash Lock White hooklift White Tilt Latch Knobs & Conceal. Plate HN10 Horns Top Sash Only Sash Restrictor White x 1 Trickle Vent - TV90 425HL White (12) Weatherstrip - White Cill Board groove Cill Drip Groove Timber - Redwood Finger Jointed Laminate Colour - RAL 9016 Traffic white To be site coupled by others Individual Unit Weight 34.857kg			
Line 16	616 x 1270mm	P2W7B	2		1
		Allan Brothers Slide & Tilt 145mm Profile Glazing - 6.8mm Lam-18-4mm Tough Soft Coat Spacer - Black Swiss V Gas - Argon Glass Protective Film 2 Sides Glazing Beads - Redwood Hinge - Top and Bottom Sash S&T PAS24 White Spiral Tubes and Stoppers Sash Lock - White Security Sash Lock White hooklift White Tilt Latch Knobs & Conceal. Plate HN10 Horns Top Sash Only Sash Restrictor White x 1 Trickle Vent - TV90 425HL White (12) Weatherstrip - White Cill Board groove Cill Drip Groove Timber - Redwood Finger Jointed Laminate Colour - RAL 9016 Traffic white To be site coupled by others Individual Unit Weight 34.857kg			
Line 17	Length: 1270mm	P2W7 Joint Pack	2		1
		Item sent loose Timber - Redwood Finger Jointed Laminate 45mm Vertical Joint Pack Colour - RAL 9016 Traffic white			

NYM/NPA  
 23/11/2015

Order ref no. 521598-3

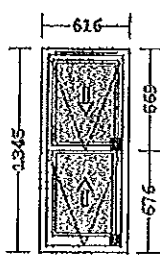
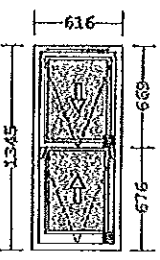
Line	Overall Size	Reference	Qty	Unit Price	Total
Line 18	616 x 1345mm	P2W9A	1		
		Allan Brothers Slide & Tilt 145mm Profile Glazing - 6.8mm Lam-18-4mm Tough Soft Coat Spacer - Black Swiss V Gas - Argon Glass Protective Film 2 Sides Glazing Beads - Redwood Hinge - Top and Bottom Sash S&T PAS24 White Spiral Tubes and Stoppers Sash Lock - White Security Sash Lock White hooklift White Tilt Latch Knobs & Conceal. Plate HN10 Horns Top Sash Only Sash Restrictor White x 1 Trickle Vent - TV90 425HL White (12) Weatherstrip - White Cill Board groove Cill Drip Groove Timber - Redwood Finger Jointed Laminate Colour - RAL 9016 Traffic white To be site coupled by others Individual Unit Weight 36.531kg			
Line 19	616 x 1345mm	P2W9B	1		
		Allan Brothers Slide & Tilt 145mm Profile Glazing - 6.8mm Lam-18-4mm Tough Soft Coat Spacer - Black Swiss V Gas - Argon Glass Protective Film 2 Sides Glazing Beads - Redwood Hinge - Top and Bottom Sash S&T PAS24 White Spiral Tubes and Stoppers Sash Lock - White Security Sash Lock White hooklift White Tilt Latch Knobs & Conceal. Plate HN10 Horns Top Sash Only Sash Restrictor White x 1 Trickle Vent - TV90 425HL White (12) Weatherstrip - White Cill Board groove Cill Drip Groove Timber - Redwood Finger Jointed Laminate Colour - RAL 9016 Traffic white To be site coupled by others Individual Unit Weight 36.531kg			
Line 20	Length: 1345mm	P2W9 Joint Pack	1		
		Item sent loose Timber - Redwood Finger Jointed Laminate 45mm Vertical Joint Pack Colour - RAL 9016 Traffic white			

NYM/NPA  
23 FEB 2015

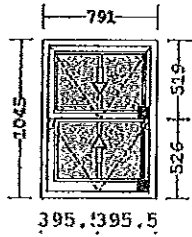
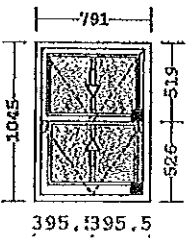
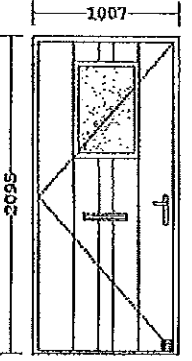
Line	Overall Size	Reference	Qty	Unit Price	Total
Line 21	791 x 1045mm	P2W11A	1		
		Allan Brothers Slide & Tilt 145mm Profile Glazing - 6.8mm Lam-18-4mm Tough Soft Coat Spacer - Black Swiss V Gas - Argon Glass Protective Film 2 Sides Glazing Beads - Redwood Hinge - Top and Bottom Sash S&T PAS24 White Spiral Tubes and Stoppers Sash Lock - White Security Sash Lock White hooklift White Tilt Latch Knobs & Conceal. Plate HN10 Horns Top Sash Only Sash Restrictor White x 1 Grilles - 25mm Bonded Bar + Swiss V Grilles Weatherstrip - White Cill Board groove Cill Drip Groove Timber - Redwood Finger Jointed Laminate Colour - RAL 9016 Traffic white No vent Individual Unit Weight 36.593kg			
Line 22	791 x 1045mm	P2W11B	1		
		Allan Brothers Slide & Tilt 145mm Profile Glazing - 6.8mm Lam-18-4mm Tough Soft Coat Spacer - Black Swiss V Gas - Argon Glass Protective Film 2 Sides Glazing Beads - Redwood Hinge - Top and Bottom Sash S&T PAS24 White Spiral Tubes and Stoppers Sash Lock - White Security Sash Lock White hooklift White Tilt Latch Knobs & Conceal. Plate HN10 Horns Top Sash Only Sash Restrictor White x 1 Grilles - 25mm Bonded Bar + Swiss V Grilles Weatherstrip - White Cill Board groove Cill Drip Groove Timber - Redwood Finger Jointed Laminate Colour - RAL 9016 Traffic white No vent Individual Unit Weight 36.593kg			
Line 23	1007 x 2095mm	P2D1	1		
		Allan Brothers Scotdoor Clyde 92mm Profile Glazing - 6.8mm Soft Coat Low E Lam-18-4mm Tough Spacer - Black Swiss V Gas - Argon Glass Protective Film 2 Sides Standard pattern to outside and inside Hinge - Zinc Hinges LH Open In Handle - Polished Chrome ProSecure Handle Chrome Letterplate + Chrome Restrictor 48-38 Nickel Thumb Turn Cylinder Threshold - StormGuard AM3 Silver Weatherstrip - White Timber - Finger Jointed Laminate Frame Spyhole with extension - Chrome Security Chain Polished Chrome Stippolyte Obscure Colour - RAL 9016 Traffic white Individual Unit Weight 150.201kg			Plots 1, 2, 5, 10 Front Door

NYMIPA  
23/11/2015

Order ref no. 521598-3

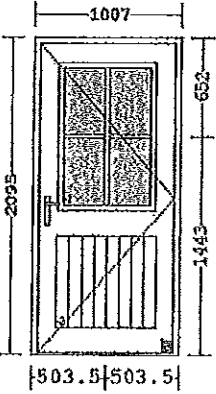
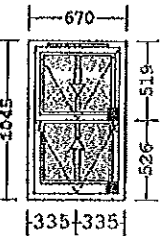
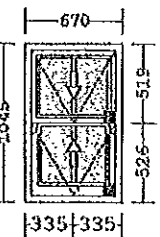
Line	Overall Size	Reference	Qty	Unit Price	Total
Line 24	1007 x 2095mm	P2D8	1		
		<p>Allan Brothers Scotdoor Dee 92mm Profile                      Glazing - 6.8mm Lam-18-4mm Tough Soft Coat                      Spacer - Black Swiss V                      Gas - Argon                      Glass Protective Film 2 Sides                      Standard pattern to outside and inside                      Hinge - Zinc Hinges                      RH Open In                      Handle - Polished Chrome ProSecure Handle                      48-38 Nickel Cylinder                      Grilles - 25mm Bonded Bar + Swiss V Grilles (11.-1)                      Threshold - StormGuard AM3 Silver                      Weatherstrip - White                      Timber - Finger Jointed Laminate Frame                      Colour - RAL 9016 Traffic white                      Individual Unit Weight 162.148kg</p>			All rear doors & Plot 9 First Floor Apartment Door
Line 25	670 x 1045mm	P3W3	1		
		<p>Allan Brothers Slide &amp; Tilt 145mm Profile                      Glazing - 4mm-20-4mm Soft Coat Low E                      Spacer - Black Swiss V                      Gas - Argon                      Glass Protective Film 2 Sides                      Glazing Beads - Redwood                      Hinge - Top and Bottom Sash S&amp;T PAS24                      White Spiral Tubes and Stoppers                      Sash Lock - White Security Sash Lock                      White hooklift                      White Tilt Latch Knobs &amp; Conceal. Plate                      HN10 Horns Top Sash Only                      Sash Restrictor White x 1                      Grilles - 25mm Bonded Bar + Swiss V Grilles                      Trickle Vent - TV90 425HL White (12)                      Weatherstrip - White                      Cill Board groove                      Cill Drip Groove                      Timber - Redwood Finger Jointed Laminate                      62mm Cill Extension                      Colour - RAL 9016 Traffic white                      Individual Unit Weight 29.228kg</p>			
Line 26	670 x 1045mm	P3W4	1		
		<p>Allan Brothers Slide &amp; Tilt 145mm Profile                      Glazing - 4mm-20-4mm Soft Coat Low E                      Spacer - Black Swiss V                      Gas - Argon                      Glass Protective Film 2 Sides                      Glazing Beads - Redwood                      Hinge - Top and Bottom Sash S&amp;T PAS24                      White Spiral Tubes and Stoppers                      Sash Lock - White Security Sash Lock                      White hooklift                      White Tilt Latch Knobs &amp; Conceal. Plate                      HN10 Horns Top Sash Only                      Sash Restrictor White x 1                      Grilles - 25mm Bonded Bar + Swiss V Grilles                      Weatherstrip - White                      Cill Board groove                      Cill Drip Groove                      Timber - Redwood Finger Jointed Laminate                      62mm Cill Extension                      Stippolyte Obscure                      Colour - RAL 9016 Traffic white                      No vent                      Individual Unit Weight 29.228kg</p>			

NYMNPA  
23 FEB 2015

# Order ref no. 521598-3

NYM / 2015 / 0 1 2 9 3 0 V 0

Line	Overall Size	Reference	Qty	Unit Price	Total
Line 27	1232 x 1270mm	P3W8	2		
		<p>Allan Brothers Slide &amp; Tilt 145mm Profile                      Glazing - 6.8mm Lam-18-4mm Tough Soft Coat                      Spacer - Black Swiss V                      Gas - Argon                      Glass Protective Film 2 Sides                      Glazing Beads - Redwood                      Hinge - Top and Bottom Sash S&amp;T PAS24                      White Spiral Tubes and Stoppers                      Sash Lock - White Security Sash Lock                      White hooklift                      White Tilt Latch Knobs &amp; Conceal. Plate                      HN10 Horns Top Sash Only                      Sash Restrictor White x 1                      Grilles - 25mm Bonded Bar + Swiss V Grilles                      Trickle Vent - TV90 425HL White (12)                      Weatherstrip - White                      Cill Board groove                      Cill Drip Groove                      Timber - Redwood Finger Jointed Laminate                      62mm Cill Extension                      Colour - RAL 9016 Traffic white                      Individual Unit Weight 62.313kg</p>			
Line 28	1232 x 1345mm	P3W10	1		
		<p>Allan Brothers Slide &amp; Tilt 145mm Profile                      Glazing - 6.8mm Lam-18-4mm Tough Soft Coat                      Spacer - Black Swiss V                      Gas - Argon                      Glass Protective Film 2 Sides                      Glazing Beads - Redwood                      Hinge - Top and Bottom Sash S&amp;T PAS24                      White Spiral Tubes and Stoppers                      Sash Lock - White Security Sash Lock                      White hooklift                      White Tilt Latch Knobs &amp; Conceal. Plate                      HN10 Horns Top Sash Only                      Sash Restrictor White x 1                      Grilles - 25mm Bonded Bar + Swiss V Grilles                      Trickle Vent - TV90 425HL White (12)                      Weatherstrip - White                      Cill Board groove                      Cill Drip Groove                      Timber - Redwood Finger Jointed Laminate                      62mm Cill Extension                      Colour - RAL 9016 Traffic white                      Individual Unit Weight 65.249kg</p>			

NYMNPA  
23 Feb 2015

Order ref no. 521598-3

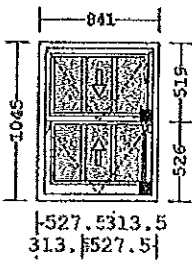
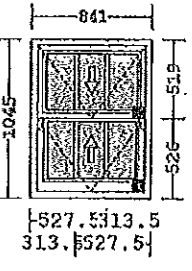
Line	Overall Size	Reference	Qty	Unit Price	Total
Line 29	841 x 1045mm	P3W12A	1		
		Allan Brothers Slide & Tilt 145mm Profile Glazing - 6,8mm Lam-18-4mm Tough Soft Coat Spacer - Black Swiss V Gas - Argon Glass Protective Film 2 Sides Glazing Beads - Redwood Hinge - Top and Bottom Sash S&T PAS24 White Spiral Tubes and Stoppers Sash Lock - White Security Sash Lock White hooklift White Tilt Latch Knobs & Conceal. Plate HN10 Horns Top Sash Only Sash Restrictor White x 1 Grilles - 25mm Bonded Bar + Swiss V Grilles Weatherstrip - White Cill Board groove Cill Drip Groove Timber - Redwood Finger Jointed Laminate Colour - RAL 9016 Traffic white No vent Individual Unit Weight 38.578kg			
Line 30	841 x 1045mm	P3W12B	1		
		Allan Brothers Slide & Tilt 145mm Profile Glazing - 6,8mm Lam-18-4mm Tough Soft Coat Spacer - Black Swiss V Gas - Argon Glass Protective Film 2 Sides Glazing Beads - Redwood Hinge - Top and Bottom Sash S&T PAS24 White Spiral Tubes and Stoppers Sash Lock - White Security Sash Lock White hooklift White Tilt Latch Knobs & Conceal. Plate HN10 Horns Top Sash Only Sash Restrictor White x 1 Grilles - 25mm Bonded Bar + Swiss V Grilles Weatherstrip - White Cill Board groove Cill Drip Groove Timber - Redwood Finger Jointed Laminate Colour - RAL 9016 Traffic white No vent Individual Unit Weight 38.578kg			
Line 31	Length: 1045mm	P3W12 Joint Pack	1		
		Item sent loose Timber - Redwood Finger Jointed Laminate 45mm Vertical Joint Pack Colour - RAL 9016 Traffic white			

NYM NPA  
23 FEB 2015

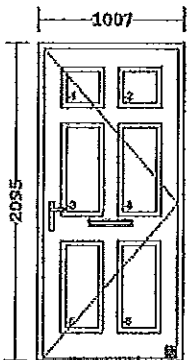
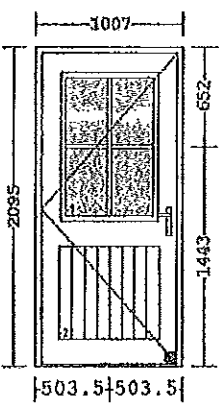
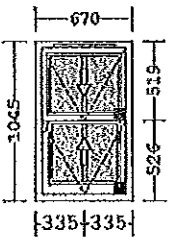
Line	Overall Size	Reference	Qty	Unit Price	Total
Line 32	1007 x 2095mm	P3D4	1		
		<p>Allan Brothers Scotdoor Don 92mm Profile                      Standard pattern to outside and inside                      Hinge - Zinc Hinges                      RH Open In                      Handle - Polished Chrome ProSecure Handle                      Chrome Letterplate + Chrome Restrictor                      48-38 Nickel Thumb Turn Cylinder                      Threshold - StormGuard AM3 Silver                      Weatherstrip - White                      Timber - Finger Jointed Laminate Frame                      Spyhole with extension - Chrome                      Security Chain Polished Chrome                      Colour - RAL 9016 Traffic white                      Individual Unit Weight 157.898kg</p>			Plots 3, 4 Front Door
Line 33	1007 x 2095mm	P3D7	1		
		<p>Allan Brothers Scotdoor Dee 92mm Profile                      Glazing - 6.8mm Lam-18-4mm Tough Soft Coat                      Spacer - Black Swiss V                      Gas - Argon                      Glass Protective Film 2 Sides                      Standard pattern to outside and inside                      Hinge - Zinc Hinges                      LH Open In                      Handle - Polished Chrome ProSecure Handle                      48-38 Nickel Cylinder                      Grilles - 25mm Bonded Bar + Swiss V Grilles (11.-1)                      Threshold - StormGuard AM3 Silver                      Weatherstrip - White                      Timber - Finger Jointed Laminate Frame                      Colour - RAL 9016 Traffic white                      Individual Unit Weight 162.148kg</p>			All rear doors & Plot 9 First Floor Apartment Door
Line 34	670 x 1045mm	P4WB	1		
		<p>Allan Brothers Slide &amp; Tilt 145mm Profile                      Glazing - 4mm-20-4mm Soft Coat Low E                      Spacer - Black Swiss V                      Gas - Argon                      Glass Protective Film 2 Sides                      Glazing Beads - Redwood                      Hinge - Top and Bottom Sash S&amp;T PAS24                      White Spiral Tubes and Stoppers                      Sash Lock - White Security Sash Lock                      White hooklift                      White Tilt Latch Knobs &amp; Conceal. Plate                      HN10 Horns Top Sash Only                      Sash Restrictor White x 1                      Grilles - 25mm Bonded Bar + Swiss V Grilles                      Trickle Vent - TV90 425HL White (12)                      Weatherstrip - White                      Cill Board groove                      Cill Drip Groove                      Timber - Redwood Finger Jointed Laminate                      62mm Cill Extension                      Colour - RAL 9016 Traffic white                      Individual Unit Weight 29.228kg</p>			NY ANPA 23/03/2015

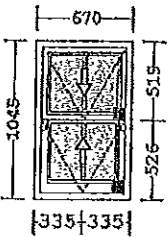
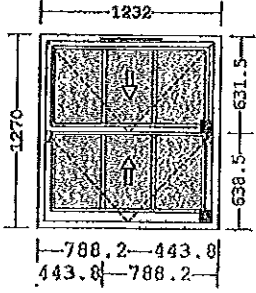

**Order ref no. 521598-3**

Line	Overall Size	Reference	Qty	Unit Price	Total
Line 35	670 x 1045mm	P4W4	1		
		Allan Brothers Slide & Tilt 145mm Profile Glazing - 4mm-20-4mm Soft Coat Low E Spacer - Black Swiss V Gas - Argon Glass Protective Film 2 Sides Glazing Beads - Redwood Hinge - Top and Bottom Sash S&T PAS24 White Spiral Tubes and Stoppers Sash Lock - White Security Sash Lock White hooklift White Tilt Latch Knobs & Conceal. Plate HN10 Horns Top Sash Only Sash Restrictor White x 1 Grilles - 25mm Bonded Bar + Swiss V Grilles Weatherstrip - White Cill Board groove Cill Drip Groove Timber - Redwood Finger Jointed Laminate 62mm Cill Extension Stippolyte Obscure Colour - RAL 9016 Traffic white No vent Individual Unit Weight 29.228kg			
Line 36	1232 x 1270mm	P4W8	2		
		Allan Brothers Slide & Tilt 145mm Profile Glazing - 6.8mm Lam-18-4mm Tough Soft Coat Spacer - Black Swiss V Gas - Argon Glass Protective Film 2 Sides Glazing Beads - Redwood Hinge - Top and Bottom Sash S&T PAS24 White Spiral Tubes and Stoppers Sash Lock - White Security Sash Lock White hooklift White Tilt Latch Knobs & Conceal. Plate HN10 Horns Top Sash Only Sash Restrictor White x 1 Grilles - 25mm Bonded Bar + Swiss V Grilles Trickle Vent - TV90 425HL White (12) Weatherstrip - White Cill Board groove Cill Drip Groove Timber - Redwood Finger Jointed Laminate 62mm Cill Extension Colour - RAL 9016 Traffic white Individual Unit Weight 62.313kg			

NYM/179  
23180 2015

# Order ref no. 521598-3

5/16 / 2015 14 2 9 3 C.V.C

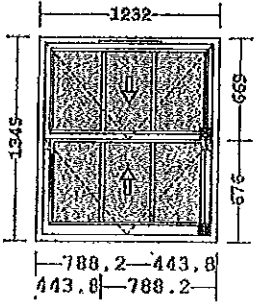
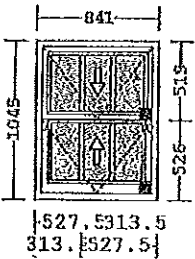
Line	Overall Size	Reference	Qty	Unit Price	Total
Line 37	1232 x 1345mm	P4W10	1		
		<p>Allan Brothers Slide &amp; Tilt 145mm Profile                      Glazing - 6.8mm Lam-18-4mm Tough Soft Coat                      Spacer - Black Swiss V                      Gas - Argon                      Glass Protective Film 2 Sides                      Glazing Beads - Redwood                      Hinge - Top and Bottom Sash S&amp;T PAS24                      White Spiral Tubes and Stoppers                      Sash Lock - White Security Sash Lock                      White hooklift                      White Tilt Latch Knobs &amp; Conceal. Plate                      HN10 Horns Top Sash Only                      Sash Restrictor White x 1                      Grilles - 25mm Bonded Bar + Swiss V Grilles                      Trickle Vent - TV90 425HL White (12)                      Weatherstrip - White                      Cill Board groove                      Cill Drip Groove                      Timber - Redwood Finger Jointed Laminate                      62mm Cill Extension                      Colour - RAL 9016 Traffic white                      Individual Unit Weight 65.249kg</p>			
Line 38	841 x 1045mm	P4W12A	1		
		<p>Allan Brothers Slide &amp; Tilt 145mm Profile                      Glazing - 6.8mm Lam-18-4mm Tough Soft Coat                      Spacer - Black Swiss V                      Gas - Argon                      Glass Protective Film 2 Sides                      Glazing Beads - Redwood                      Hinge - Top and Bottom Sash S&amp;T PAS24                      White Spiral Tubes and Stoppers                      Sash Lock - White Security Sash Lock                      White hooklift                      White Tilt Latch Knobs &amp; Conceal. Plate                      HN10 Horns Top Sash Only                      Sash Restrictor White x 1                      Grilles - 25mm Bonded Bar + Swiss V Grilles                      Weatherstrip - White                      Cill Board groove                      Cill Drip Groove                      Timber - Redwood Finger Jointed Laminate                      Colour - RAL 9016 Traffic white                      No vent                      Individual Unit Weight 38.578kg</p>			

NYMNPA  
 23/11/2015

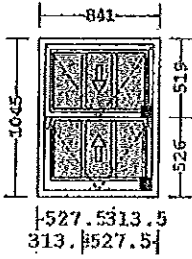
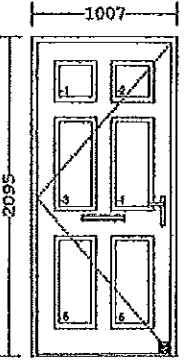
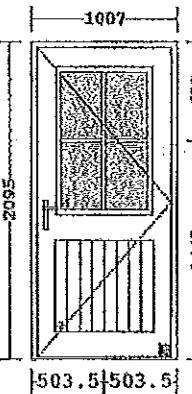
Line	Overall Size	Reference	Qty	Unit Price	Total
Line 39	841 x 1045mm	P4W12B	1		
		Allan Brothers Slide & Tilt 145mm Profile Glazing - 6.8mm Lam-18-4mm Tough Soft Coat Spacer - Black Swiss V Gas - Argon Glass Protective Film 2 Sides Glazing Beads - Redwood Hinge - Top and Bottom Sash S&T PAS24 White Spiral Tubes and Stoppers Sash Lock - White Security Sash Lock White hooklift White Tilt Latch Knobs & Conceal. Plate HN10 Horns Top Sash Only Sash Restrictor White x 1 Grilles - 25mm Bonded Bar + Swiss V Grilles Weatherstrip - White Cill Board groove Cill Drip Groove Timber - Redwood Finger Jointed Laminate Colour - RAL 9016 Traffic white No vent Individual Unit Weight 38.578kg			
Line 40	Length: 1045mm	P4W12 Joint Pack	1		
		Item sent loose Timber - Redwood Finger Jointed Laminate 45mm Vertical Joint Pack Colour - RAL 9016 Traffic white			
Line 41	1007 x 2095mm	P4D3	1		
		Allan Brothers Scotdoor Don 92mm Profile Standard pattern to outside and inside Hinge - Zinc Hinges LH Open In Handle - Polished Chrome ProSecure Handle Chrome Letterplate + Chrome Restrictor 48-38 Nickel Thumb Turn Cylinder Threshold - StormGuard AM3 Silver Weatherstrip - White Timber - Finger Jointed Laminate Frame Spyhole with extension - Chrome Security Chain Polished Chrome Colour - RAL 9016 Traffic white Individual Unit Weight 157.898kg			Plots 3, 4 Front Door
Line 42	1007 x 2095mm	P4D8	1		
		Allan Brothers Scotdoor Dee 92mm Profile Glazing - 6.8mm Lam-18-4mm Tough Soft Coat Spacer - Black Swiss V Gas - Argon Glass Protective Film 2 Sides Standard pattern to outside and inside Hinge - Zinc Hinges RH Open In Handle - Polished Chrome ProSecure Handle 48-38 Nickel Cylinder Grilles - 25mm Bonded Bar + Swiss V Grilles (11,-1) Threshold - StormGuard AM3 Silver Weatherstrip - White Timber - Finger Jointed Laminate Frame Colour - RAL 9016 Traffic white Individual Unit Weight 162.148kg			All rear doors & Plot 9 First Floor Apartment Door

NYMNP  
23 FEB 2015

# Order ref no. 521598-3

NYM / 2015 / 11 / 23 / 11 / 10

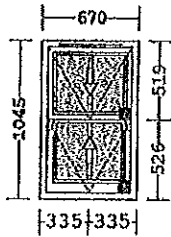
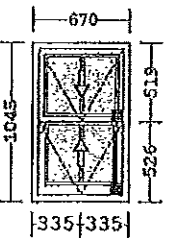
Line	Overall Size	Reference	Qty	Unit Price	Total
Line 43	670 x 1045mm	P5W3	1		
		<p>Allan Brothers Slide &amp; Tilt 145mm Profile                      Glazing - 4mm-20-4mm Soft Coat Low E                      Spacer - Black Swiss V                      Gas - Argon                      Glass Protective Film 2 Sides                      Glazing Beads - Redwood                      Hinge - Top and Bottom Sash S&amp;T PAS24                      White Spiral Tubes and Stoppers                      Sash Lock - White Security Sash Lock                      White hooklift                      White Tilt Latch Knobs &amp; Conceal. Plate                      HN10 Horns Top Sash Only                      Sash Restrictor White x 1                      Grilles - 25mm Bonded Bar + Swiss V Grilles                      Trickle Vent - TV90 425HL White (12)                      Weatherstrip - White                      Cill Board groove                      Cill Drip Groove                      Timber - Redwood Finger Jointed Laminate                      62mm Cill Extension                      Colour - RAL 9016 Traffic white                      Individual Unit Weight 29.228kg</p>			
Line 44	670 x 1045mm	P5W4	1		
		<p>Allan Brothers Slide &amp; Tilt 145mm Profile                      Glazing - 4mm-20-4mm Soft Coat Low E                      Spacer - Black Swiss V                      Gas - Argon                      Glass Protective Film 2 Sides                      Glazing Beads - Redwood                      Hinge - Top and Bottom Sash S&amp;T PAS24                      White Spiral Tubes and Stoppers                      Sash Lock - White Security Sash Lock                      White hooklift                      White Tilt Latch Knobs &amp; Conceal. Plate                      HN10 Horns Top Sash Only                      Sash Restrictor White x 1                      Grilles - 25mm Bonded Bar + Swiss V Grilles                      Weatherstrip - White                      Cill Board groove                      Cill Drip Groove                      Timber - Redwood Finger Jointed Laminate                      62mm Cill Extension                      Stippolyte Obscure                      Colour - RAL 9016 Traffic white                      No vent                      Individual Unit Weight 29.228kg</p>			

NYM NPA  
23 FEB 2015

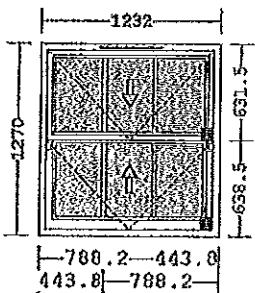
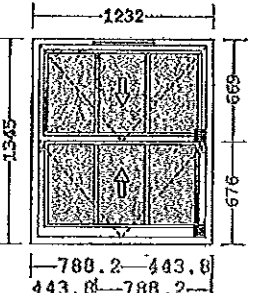
Line	Overall Size	Reference	Qty	Unit Price	Total
Line 45	1232 x 1270mm	P5W8	2		
		<p>Allan Brothers Slide &amp; Tilt 145mm Profile                      Glazing - 6.8mm Lam-18-4mm Tough Soft Coat                      Spacer - Black Swiss V                      Gas - Argon                      Glass Protective Film 2 Sides                      Glazing Beads - Redwood                      Hinge - Top and Bottom Sash S&amp;T PAS24                      White Spiral Tubes and Stoppers                      Sash Lock - White Security Sash Lock                      White hooklift                      White Tilt Latch Knobs &amp; Conceal. Plate                      HN10 Horns Top Sash Only                      Sash Restrictor White x 1                      Grilles - 25mm Bonded Bar + Swiss V Grilles                      Trickle Vent - TV90 425HL White (12)                      Weatherstrip - White                      Cill Board groove                      Cill Drip Groove                      Timber - Redwood Finger Jointed Laminate                      62mm Cill Extension                      Colour - RAL 9016 Traffic white                      Individual Unit Weight 62.313kg</p>			
Line 46	1232 x 1845mm	P5W10	1		
		<p>Allan Brothers Slide &amp; Tilt 145mm Profile                      Glazing - 6.8mm Lam-18-4mm Tough Soft Coat                      Spacer - Black Swiss V                      Gas - Argon                      Glass Protective Film 2 Sides                      Glazing Beads - Redwood                      Hinge - Top and Bottom Sash S&amp;T PAS24                      White Spiral Tubes and Stoppers                      Sash Lock - White Security Sash Lock                      White hooklift                      White Tilt Latch Knobs &amp; Conceal. Plate                      HN10 Horns Top Sash Only                      Sash Restrictor White x 1                      Grilles - 25mm Bonded Bar + Swiss V Grilles                      Trickle Vent - TV90 425HL White (12)                      Weatherstrip - White                      Cill Board groove                      Cill Drip Groove                      Timber - Redwood Finger Jointed Laminate                      62mm Cill Extension                      Colour - RAL 9016 Traffic white                      Individual Unit Weight 65.249kg</p>			

NYMAN  
23 FEB 2015

# Order ref no. 521598-3

NYMANIA 23 FEB 2015

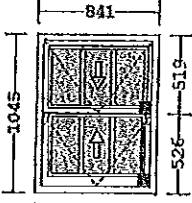
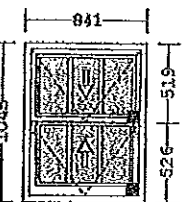
Line	Overall Size	Reference	Qty	Unit Price	Total
Line 47	841 x 1045mm	P5W12A	1		
 <p style="font-size: small;"> <span style="display: inline-block; width: 100px; border-bottom: 1px solid black;"></span> 841  <span style="display: inline-block; height: 100px; border-right: 1px solid black;"></span> 1045  <span style="display: inline-block; width: 50px; border-bottom: 1px solid black;"></span> 519  <span style="display: inline-block; width: 50px; border-bottom: 1px solid black;"></span> 526  <span style="display: inline-block; width: 50px; border-bottom: 1px solid black;"></span> 527.5                 </p>		Allan Brothers Slide & Tilt 145mm Profile Glazing - 6.8mm Lam-18-4mm Tough Soft Coat Spacer - Black Swiss V Gas - Argon Glass Protective Film 2 Sides Glazing Beads - Redwood Hinge - Top and Bottom Sash S&T PAS24 White Spiral Tubes and Stoppers Sash Lock - White Security Sash Lock White hooklift White Tilt Latch Knobs & Conceal. Plate HN10 Horns Top Sash Only Sash Restrictor White x 1 Grilles - 25mm Bonded Bar + Swiss V Grilles Weatherstrip - White Cill Board groove Cill Drip Groove Timber - Redwood Finger Jointed Laminate Colour - RAL 9016 Traffic white No vent Individual Unit Weight 38.578kg			
Line 48	841 x 1045mm	P5W12B	1		
 <p style="font-size: small;"> <span style="display: inline-block; width: 100px; border-bottom: 1px solid black;"></span> 841  <span style="display: inline-block; height: 100px; border-right: 1px solid black;"></span> 1045  <span style="display: inline-block; width: 50px; border-bottom: 1px solid black;"></span> 519  <span style="display: inline-block; width: 50px; border-bottom: 1px solid black;"></span> 526  <span style="display: inline-block; width: 50px; border-bottom: 1px solid black;"></span> 527.5                 </p>		Allan Brothers Slide & Tilt 145mm Profile Glazing - 6.8mm Lam-18-4mm Tough Soft Coat Spacer - Black Swiss V Gas - Argon Glass Protective Film 2 Sides Glazing Beads - Redwood Hinge - Top and Bottom Sash S&T PAS24 White Spiral Tubes and Stoppers Sash Lock - White Security Sash Lock White hooklift White Tilt Latch Knobs & Conceal. Plate HN10 Horns Top Sash Only Sash Restrictor White x 1 Grilles - 25mm Bonded Bar + Swiss V Grilles Weatherstrip - White Cill Board groove Cill Drip Groove Timber - Redwood Finger Jointed Laminate Colour - RAL 9016 Traffic white No vent Individual Unit Weight 38.578kg			
Line 49	Length: 1045mm	P5W12 Joint Pack	1		
		Item sent loose Timber - Redwood Finger Jointed Laminate 45mm Vertical Joint Pack Colour - RAL 9016 Traffic white			

NYMANIA  
23 FEB 2015

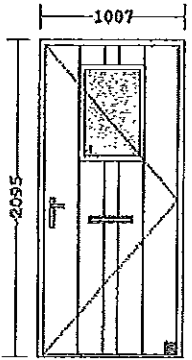
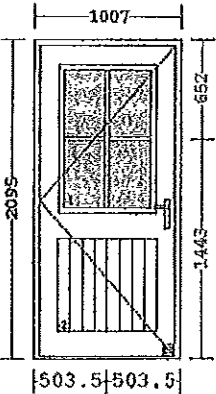
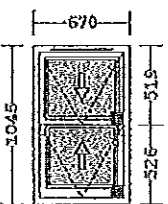
Line	Overall Size	Reference	Qty	Unit Price	Total
Line 50	1007 x 2095mm	P5D2	1		
		<p>Allan Brothers Scotdoor Clyde 92mm Profile                      Glazing - 6.8mm Soft Coat Low E Lam-18-4mm Tough                      Spacer - Black Swiss V                      Gas - Argon                      Glass Protective Film 2 Sides                      Standard pattern to outside and inside                      Hinge - Zinc Hinges                      RH Open In                      Handle - Polished Chrome ProSecure Handle                      Chrome Letterplate + Chrome Restrictor                      48-38 Nickel Thumb Turn Cylinder                      Threshold - StormGuard AM3 Silver                      Weatherstrip - White                      Timber - Finger Jointed Laminate Frame                      Spyhole with extension - Chrome                      Security Chain Polished Chrome                      Stippolyte Obscure                      Colour - RAL 9016 Traffic white                      Individual Unit Weight 150.201kg</p>			Plots 1, 2, 5, 10 Front Door
Line 51	1007 x 2095mm	P5D7	1		
		<p>Allan Brothers Scotdoor Dee 92mm Profile                      Glazing - 6.8mm Lam-18-4mm Tough Soft Coat                      Spacer - Black Swiss V                      Gas - Argon                      Glass Protective Film 2 Sides                      Standard pattern to outside and inside                      Hinge - Zinc Hinges                      LH Open In                      Handle - Polished Chrome ProSecure Handle                      48-38 Nickel Cylinder                      Grilles - 25mm Bonded Bar + Swiss V Grilles (11,-1)                      Threshold - StormGuard AM3 Silver                      Weatherstrip - White                      Timber - Finger Jointed Laminate Frame                      Colour - RAL 9016 Traffic white                      Individual Unit Weight 162.148kg</p>			All rear doors & Plot 9 First Floor Apartment Door
Line 52	670 x 1045mm	P6W1	1		
		<p>Allan Brothers Slide &amp; Tilt 145mm Profile                      Glazing - 4mm-20-4mm Soft Coat Low E                      Spacer - Black Swiss V                      Gas - Argon                      Glass Protective Film 2 Sides                      Glazing Beads - Redwood                      Hinge - Top and Bottom Sash S&amp;T PAS24                      White Spiral Tubes and Stoppers                      Sash Lock - White Security Sash Lock                      White hooklift                      White Tilt Latch Knobs &amp; Conceal. Plate                      HN10 Horns Top Sash Only                      Sash Restrictor White x 1                      Trickle Vent - TV90 425HL White (12)                      Weatherstrip - White                      Cill Board groove                      Cill Drip Groove                      Timber - Redwood Finger Jointed Laminate                      62mm Cill Extension                      Colour - RAL 9016 Traffic white                      Individual Unit Weight 29.152kg</p>			

NYM/PA  
23/09/2015

# Order ref no. 521598-3

NYM / 2015 / 0128 / CVC

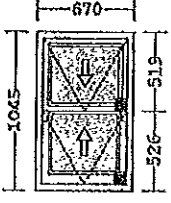
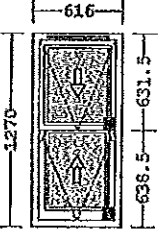
Line	Overall Size	Reference	Qty	Unit Price	Total
Line 53	670 x 1045mm	P6W2	1		
		Allan Brothers Slide & Tilt 145mm Profile Glazing - 4mm-20-4mm Soft Coat Low E Spacer - Black Swiss V Gas - Argon Glass Protective Film 2 Sides Glazing Beads - Redwood Hinge - Top and Bottom Sash S&T PAS24 White Spiral Tubes and Stoppers Sash Lock - White Security Sash Lock White hooklift White Tilt Latch Knobs & Conceal. Plate HN10 Horns Top Sash Only Sash Restrictor White x 1 Weatherstrip - White Cill Board groove Cill Drip Groove Timber - Redwood Finger Jointed Laminate 62mm Cill Extension Stippolyte Obscure Colour - RAL 9016 Traffic white No vent Individual Unit Weight 29.152kg			
Line 54	616 x 1270mm	P6W7A	2		
		Allan Brothers Slide & Tilt 145mm Profile Glazing - 6.8mm Lam-18-4mm Tough Soft Coat Spacer - Black Swiss V Gas - Argon Glass Protective Film 2 Sides Glazing Beads - Redwood Hinge - Top and Bottom Sash S&T PAS24 White Spiral Tubes and Stoppers Sash Lock - White Security Sash Lock White hooklift White Tilt Latch Knobs & Conceal. Plate HN10 Horns Top Sash Only Sash Restrictor White x 1 Trickle Vent - TV90 425HL White (12) Weatherstrip - White Cill Board groove Cill Drip Groove Timber - Redwood Finger Jointed Laminate Colour - RAL 9016 Traffic white To be site coupled by others Individual Unit Weight 34.857kg			

NYM/NPA  
23/03/2015

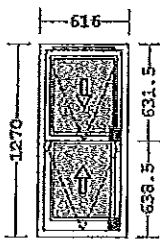
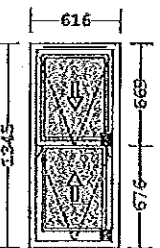

Line	Overall Size	Reference	Qty	Unit Price	Total
Line 55	616 x 1270mm	P6W7B	2		
		Allan Brothers Slide & Tilt 145mm Profile Glazing - 6.8mm Lam-18-4mm Tough Soft Coat Spacer - Black Swiss V Gas - Argon Glass Protective Film 2 Sides Glazing Beads - Redwood Hinge - Top and Bottom Sash S&T PAS24 White Spiral Tubes and Stoppers Sash Lock - White Security Sash Lock White hooklift White Tilt Latch Knobs & Conceal. Plate HN10 Horns Top Sash Only Sash Restrictor White x 1 Trickle Vent - TV90 425HL White (12) Weatherstrip - White Cill Board groove Cill Drip Groove Timber - Redwood Finger Jointed Laminate Colour - RAL 9016 Traffic white To be site coupled by others Individual Unit Weight 34.857kg			
Line 56	Length: 1270mm	P6W7 Joint Pack	2		
		Item sent loose Timber - Redwood Finger Jointed Laminate 45mm Vertical Joint Pack Colour - RAL 9016 Traffic white			
Line 57	616 x 1345mm	P6W9A	1		
		Allan Brothers Slide & Tilt 145mm Profile Glazing - 6.8mm Lam-18-4mm Tough Soft Coat Spacer - Black Swiss V Gas - Argon Glass Protective Film 2 Sides Glazing Beads - Redwood Hinge - Top and Bottom Sash S&T PAS24 White Spiral Tubes and Stoppers Sash Lock - White Security Sash Lock White hooklift White Tilt Latch Knobs & Conceal. Plate HN10 Horns Top Sash Only Sash Restrictor White x 1 Trickle Vent - TV90 425HL White (12) Weatherstrip - White Cill Board groove Cill Drip Groove Timber - Redwood Finger Jointed Laminate Colour - RAL 9016 Traffic white To be site coupled by others Individual Unit Weight 36.531kg			

NYM NPA  
23 FEB 2015

# Order ref no. 521598-3

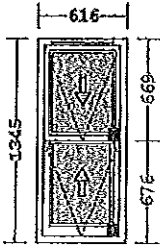
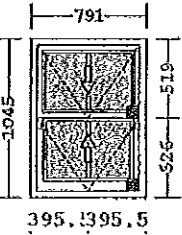
Line	Overall Size	Reference	Qty	Unit Price	Total
Line 58	616 x 1345mm	P6W9B	1		
		<p>Allan Brothers Slide &amp; Tilt 145mm Profile                      Glazing - 6.8mm Lam-18-4mm Tough Soft Coat                      Spacer - Black Swiss V                      Gas - Argon                      Glass Protective Film 2 Sides                      Glazing Beads - Redwood                      Hinge - Top and Bottom Sash S&amp;T PAS24                      White Spiral Tubes and Stoppers                      Sash Lock - White Security Sash Lock                      White hooklift                      White Tilt Latch Knobs &amp; Conceal. Plate                      HN10 Horns Top Sash Only                      Sash Restrictor White x 1                      Trickle Vent - TV90 425HL White (12)                      Weatherstrip - White                      Cill Board groove                      Cill Drip Groove                      Timber - Redwood Finger Jointed Laminate                      Colour - RAL 9016 Traffic white                      To be site coupled by others                      Individual Unit Weight 36.531kg</p>			
Line 59	Length: 1345mm	P6W9 Joint Pack	1		
		<p>Item sent loose                      Timber - Redwood Finger Jointed Laminate                      45mm Vertical Joint Pack                      Colour - RAL 9016 Traffic white</p>			
Line 60	791 x 1045mm	P6W11A	1		
		<p>Allan Brothers Slide &amp; Tilt 145mm Profile                      Glazing - 6.8mm Lam-18-4mm Tough Soft Coat                      Spacer - Black Swiss V                      Gas - Argon                      Glass Protective Film 2 Sides                      Glazing Beads - Redwood                      Hinge - Top and Bottom Sash S&amp;T PAS24                      White Spiral Tubes and Stoppers                      Sash Lock - White Security Sash Lock                      White hooklift                      White Tilt Latch Knobs &amp; Conceal. Plate                      HN10 Horns Top Sash Only                      Sash Restrictor White x 1                      Grilles - 25mm Bonded Bar + Swiss V Grilles                      Weatherstrip - White                      Cill Board groove                      Cill Drip Groove                      Timber - Redwood Finger Jointed Laminate                      Colour - RAL 9016 Traffic white                      No vent                      Individual Unit Weight 36.593kg</p>			

NYMNP

231

23 FEB 2015

Order ref no. 521598-3

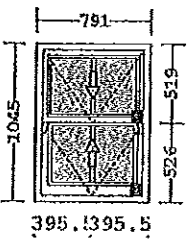
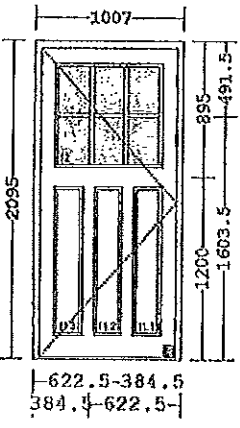
Line	Overall Size	Reference	Qty	Unit Price	T
Line 61	791 x 1045mm	P6W11B	1	1	
		<p>Allan Brothers Slide &amp; Tilt 145mm Profile                      Glazing - 6.8mm Lam-18-4mm Tough Soft Coat                      Spacer - Black Swiss V                      Gas - Argon                      Glass Protective Film 2 Sides                      Glazing Beads - Redwood                      Hinge - Top and Bottom Sash S&amp;T PAS24                      White Spiral Tubes and Stoppers                      Sash Lock - White Security Sash Lock                      White hooklift                      White Tilt Latch Knobs &amp; Conceal. Plate                      HN10 Horns Top Sash Only                      Sash Restrictor White x 1                      Grilles - 25mm Bonded Bar + Swiss V Grilles                      Weatherstrip - White                      Cill Board groove                      Cill Drip Groove                      Timber - Redwood Finger Jointed Laminate                      Colour - RAL 9016 Traffic white                      No vent                      Individual Unit Weight 36.593kg</p>			
Line 62	1007 x 2095mm	P6D6	1		
		<p>Allan Brothers A-Series Open In French Door 92mm Profile                      Glazing - 6.8mm Soft Coat Low E Lam-18-4mm Tough                      Spacer - Black Swiss V                      Gas - Argon                      Glass Protective Film 2 Sides                      Panel - 28mm Plain Security Panel Hemlock (11.11.11/11.11.21/11.11.31)                      Glazing Beads - Redwood                      Bottom Bead - Redwood                      Hinge - Zinc Hinges                      RH Open In                      Handle - Polished Chrome ProSecure Handle                      Chrome Letterplate + Chrome Restrictor                      48-38 Nickel Thumb Turn Cylinder                      162mm Solid Bar Horizontal AF/NF                      116mm Solid Bar Vertical AC/AF (11.11)                      Grilles - 25mm Bonded Bar + Swiss V Grilles (11.12)                      Threshold - StormGuard AM3 Silver                      Weatherstrip - White                      Head Drip Groove                      Timber - Redwood Finger Jointed Laminate                      DH15 Head Drip                      Security Chain Polished Chrome                      Spyhole without extension - Chrome                      Stippolyte Obscure                      Colour - RAL 9016 Traffic white                      Individual Unit Weight 68.552kg</p>			Plots 6, 7 Front Door

NYM NPA  
23 FEB 2015

# Order ref no. 521598-3

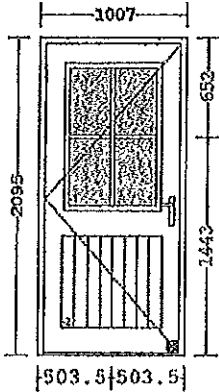
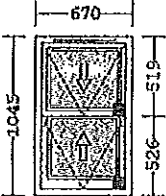
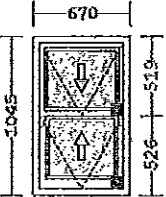
Line	Overall Size	Reference	Qty	Unit Price	Total
Line 63	1007 x 2095mm	P6D7	1		
		<p>Allen Brothers Scotdoor Dee 92mm Profile                      Glazing - 6.8mm Lam-18-4mm Tough Soft Coat                      Spacer - Black Swiss V                      Gas - Argon                      Glass Protective Film 2 Sides                      Standard pattern to outside and inside                      Hinge - Zinc Hinges                      LH Open In                      Handle - Polished Chrome ProSecure Handle                      48-38 Nickel Cylinder                      Grilles - 25mm Bonded Bar + Swiss V Grilles (11,-1)                      Threshold - StormGuard AM3 Silver                      Weatherstrip - White                      Timber - Finger Jointed Laminate Frame                      Colour - RAL 9016 Traffic white                      Individual Unit Weight 162.148kg</p>			All rear doors & Plot 9 First Floor Apartment Door
Line 64	670 x 1045mm	P7W1	1		
		<p>Allen Brothers Slide &amp; Tilt 145mm Profile                      Glazing - 4mm-20-4mm Soft Coat Low E                      Spacer - Black Swiss V                      Gas - Argon                      Glass Protective Film 2 Sides                      Glazing Beads - Redwood                      Hinge - Top and Bottom Sash S&amp;T PAS24                      White Spiral Tubes and Stoppers                      Sash Lock - White Security Sash Lock                      White hooklift                      White Tilt Latch Knobs &amp; Conceal. Plate                      HN10 Horns Top Sash Only                      Sash Restrictor White x 1                      Trickle Vent - TV90 425HL White (12)                      Weatherstrip - White                      Cill Board groove                      Cill Drip Groove                      Timber - Redwood Finger Jointed Laminate                      62mm Cill Extension                      Colour - RAL 9016 Traffic white                      Individual Unit Weight 29.152kg</p>			
Line 65	670 x 1045mm	P7W2	1		
		<p>Allen Brothers Slide &amp; Tilt 145mm Profile                      Glazing - 4mm-20-4mm Soft Coat Low E                      Spacer - Black Swiss V                      Gas - Argon                      Glass Protective Film 2 Sides                      Glazing Beads - Redwood                      Hinge - Top and Bottom Sash S&amp;T PAS24                      White Spiral Tubes and Stoppers                      Sash Lock - White Security Sash Lock                      White hooklift                      White Tilt Latch Knobs &amp; Conceal. Plate                      HN10 Horns Top Sash Only                      Sash Restrictor White x 1                      Weatherstrip - White                      Cill Board groove                      Cill Drip Groove                      Timber - Redwood Finger Jointed Laminate                      62mm Cill Extension                      Stippolyte Obscure                      Colour - RAL 9016 Traffic white                      No vent                      Individual Unit Weight 29.152kg</p>			

2017-01-2018

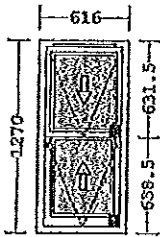
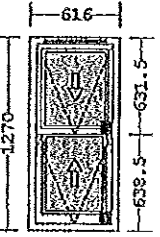
Line	Overall Size	Reference	Qty	Unit Price	Tol
Line 66	616 x 1270mm	P7W7A	2		
		Allan Brothers Slide & Tilt 145mm Profile Glazing - 6.8mm Lam-18-4mm Tough Soft Coat Spacer - Black Swiss V Gas - Argon Glass Protective Film 2 Sides Glazing Beads - Redwood Hinge - Top and Bottom Sash S&T PAS24 White Spiral Tubes and Stoppers Sash Lock - White Security Sash Lock White hooklift White Tilt Latch Knobs & Conceal. Plate HN10 Horns Top Sash Only Sash Restrictor White x 1 Trickle Vent - TV90 425HL White (12) Weatherstrip - White Cill Board groove Cill Drip Groove Timber - Redwood Finger Jointed Laminate Colour - RAL 9016 Traffic white To be site coupled by others Individual Unit Weight 34.857kg			
Line 67	616 x 1270mm	P7W7B	2		
		Allan Brothers Slide & Tilt 145mm Profile Glazing - 6.8mm Lam-18-4mm Tough Soft Coat Spacer - Black Swiss V Gas - Argon Glass Protective Film 2 Sides Glazing Beads - Redwood Hinge - Top and Bottom Sash S&T PAS24 White Spiral Tubes and Stoppers Sash Lock - White Security Sash Lock White hooklift White Tilt Latch Knobs & Conceal. Plate HN10 Horns Top Sash Only Sash Restrictor White x 1 Trickle Vent - TV90 425HL White (12) Weatherstrip - White Cill Board groove Cill Drip Groove Timber - Redwood Finger Jointed Laminate Colour - RAL 9016 Traffic white To be site coupled by others Individual Unit Weight 34.857kg			
Line 68	Length: 1270mm	P7W7 Joint Pack	2		
		Item sent loose Timber - Redwood Finger Jointed Laminate 45mm Vertical Joint Pack Colour - RAL 9016 Traffic white			

NYMNPA  
23 Feb 2015

# Order ref no. 521598-3

2015 / 01 / 29 / 09:00

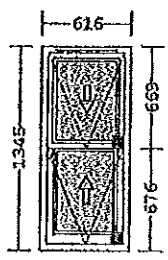
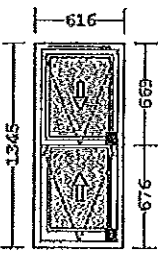
Line	Overall Size	Reference	Qty	Unit Price	Total
Line 69	616 x 1345mm	P7W9A	1		
		<p>Allan Brothers Slide &amp; Tilt 145mm Profile                      Glazing - 6.8mm Lam-18-4mm Tough Soft Coat                      Spacer - Black Swiss V                      Gas - Argon                      Glass Protective Film 2 Sides                      Glazing Beads - Redwood                      Hinge - Top and Bottom Sash S&amp;T PAS24                      White Spiral Tubes and Stoppers                      Sash Lock - White Security Sash Lock                      White hooklift                      White Tilt Latch Knobs &amp; Conceal. Plate                      HN10 Horns Top Sash Only                      Sash Restrictor White x 1                      Trickle Vent - TV90 425HL White (12)                      Weatherstrip - White                      Cill Board groove                      Cill Drip Groove                      Timber - Redwood Finger Jointed Laminate                      Colour - RAL 9016 Traffic white                      To be site coupled by others                      Individual Unit Weight 36.531kg</p>			
Line 70	616 x 1345mm	P7W9B	1		
		<p>Allan Brothers Slide &amp; Tilt 145mm Profile                      Glazing - 6.8mm Lam-18-4mm Tough Soft Coat                      Spacer - Black Swiss V                      Gas - Argon                      Glass Protective Film 2 Sides                      Glazing Beads - Redwood                      Hinge - Top and Bottom Sash S&amp;T PAS24                      White Spiral Tubes and Stoppers                      Sash Lock - White Security Sash Lock                      White hooklift                      White Tilt Latch Knobs &amp; Conceal. Plate                      HN10 Horns Top Sash Only                      Sash Restrictor White x 1                      Trickle Vent - TV90 425HL White (12)                      Weatherstrip - White                      Cill Board groove                      Cill Drip Groove                      Timber - Redwood Finger Jointed Laminate                      Colour - RAL 9016 Traffic white                      To be site coupled by others                      Individual Unit Weight 36.531kg</p>			
Line 71	Length: 1345mm	P7W9 Joint Pack	1		
		<p>Item sent loose                      Timber - Redwood Finger Jointed Laminate                      45mm Vertical Joint Pack                      Colour - RAL 9016 Traffic white</p>			

NYMNP  
 23 MAR 2015

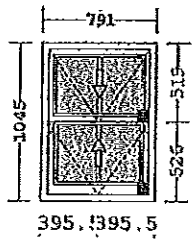
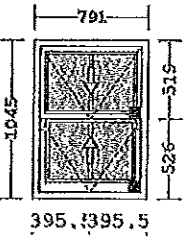
Line	Overall Size	Reference	Qty	Unit Price	T
Line 72	791 x 1045mm	P7W11A	1		
		<p>Allan Brothers Slide &amp; Tilt 145mm Profile                      Glazing - 6.8mm Lam-18-4mm Tough Soft Coat                      Spacer - Black Swiss V                      Gas - Argon                      Glass Protective Film 2 Sides                      Glazing Beads - Redwood                      Hinge - Top and Bottom Sash S&amp;T PAS24                      White Spiral Tubes and Stoppers                      Sash Lock - White Security Sash Lock                      White hooklift                      White Tilt Latch Knobs &amp; Conceal. Plate                      HN10 Horns Top Sash Only                      Sash Restrictor White x 1                      Grilles - 25mm Bonded Bar + Swiss V Grilles                      Weatherstrip - White                      Cill Board groove                      Cill Drip Groove                      Timber - Redwood Finger Jointed Laminate                      Colour - RAL 9016 Traffic white                      No vent                      Individual Unit Weight 36.593kg</p>			
Line 73	791 x 1045mm	P7W11B	1		
		<p>Allan Brothers Slide &amp; Tilt 145mm Profile                      Glazing - 6.8mm Lam-18-4mm Tough Soft Coat                      Spacer - Black Swiss V                      Gas - Argon                      Glass Protective Film 2 Sides                      Glazing Beads - Redwood                      Hinge - Top and Bottom Sash S&amp;T PAS24                      White Spiral Tubes and Stoppers                      Sash Lock - White Security Sash Lock                      White hooklift                      White Tilt Latch Knobs &amp; Conceal. Plate                      HN10 Horns Top Sash Only                      Sash Restrictor White x 1                      Grilles - 25mm Bonded Bar + Swiss V Grilles                      Weatherstrip - White                      Cill Board groove                      Cill Drip Groove                      Timber - Redwood Finger Jointed Laminate                      Colour - RAL 9016 Traffic white                      No vent                      Individual Unit Weight 36.593kg</p>			

NYM NPA  
 23 FEB 2015

# Order ref no. 521598-3

18/07/2015 10:12:00

Line	Overall Size	Reference	Qty	Unit Price	Total
Line 74	1007 x 2095mm	P7D5	1		
		<p>Allan Brothers A-Series Open In French Door 92mm Profile                      Glazing - 6.8mm Soft Coat Low E Lam-18-4mm Tough                      Spacer - Black Swiss V                      Gas - Argon                      Glass Protective Film 2 Sides                      Panel - 28mm Plain Security Panel Hemlock (11.11,11/11.11,21/11.11,31)                      Glazing Beads - Redwood                      Bottom Bead - Redwood                      Hinge - Zinc Hinges                      LH Open In                      Handle - Polished Chrome ProSecure Handle                      Chrome Letterplate + Chrome Restrictor                      48-38 Nickel Thumb Turn Cylinder                      162mm Solid Bar Horizontal AF/NF                      116mm Solid Bar Vertical AC/AF (11.11)                      Grilles - 25mm Bonded Bar + Swiss V Grilles (11.12)                      Threshold - StormGuard AM3 Silver                      Weatherstrip - White                      Head Drip Groove                      Timber - Redwood Finger Jointed Laminate                      DH15 Head Drip                      Security Chain Polished Chrome                      Spyhole without extension - Chrome                      Stippolyte Obscure                      Colour - RAL 9016 Traffic white                      Individual Unit Weight 68.552kg</p>			Plots 6, 7 Front Door
Line 75	1007 x 2095mm	P7D8	1		
		<p>Allan Brothers Scotdoor Dee 92mm Profile                      Glazing - 6.8mm Lam-18-4mm Tough Soft Coat                      Spacer - Black Swiss V                      Gas - Argon                      Glass Protective Film 2 Sides                      Standard pattern to outside and inside                      Hinge - Zinc Hinges                      RH Open In                      Handle - Polished Chrome ProSecure Handle                      48-38 Nickel Cylinder                      Grilles - 25mm Bonded Bar + Swiss V Grilles (11.-1)                      Threshold - StormGuard AM3 Silver                      Weatherstrip - White                      Timber - Finger Jointed Laminate Frame                      Colour - RAL 9016 Traffic white                      Individual Unit Weight 162.148kg</p>			All rear doors & Plot 9 First Floor Apartment Door

NOTED  
23/10/2015



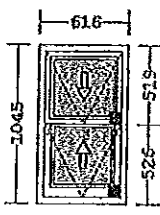
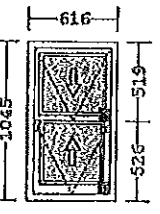

Line	Overall Size	Reference	Qty	Unit Price	Total
Line 78	616 x 1045mm	P8W6A	1		
		Allan Brothers Slide & Tilt 145mm Profile Glazing - 6.8mm Lam-18-4mm Tough Soft Coat Spacer - Black Swiss V Gas - Argon Glass Protective Film 2 Sides Glazing Beads - Redwood Hinge - Top and Bottom Sash S&T PAS24 White Spiral Tubes and Stoppers Sash Lock - White Security Sash Lock White hooklift White Tilt Latch Knobs & Conceal. Plate HN10 Horns Top Sash Only Sash Restrictor White x 1 Weatherstrip - White Cill Board groove Cill Drip Groove Timber - Redwood Finger Jointed Laminate Colour - RAL 9016 Traffic white To be site coupled by others No vent Individual Unit Weight 29.836kg			
Line 79	616 x 1045mm	P8W6B	1		
		Allan Brothers Slide & Tilt 145mm Profile Glazing - 6.8mm Lam-18-4mm Tough Soft Coat Spacer - Black Swiss V Gas - Argon Glass Protective Film 2 Sides Glazing Beads - Redwood Hinge - Top and Bottom Sash S&T PAS24 White Spiral Tubes and Stoppers Sash Lock - White Security Sash Lock White hooklift White Tilt Latch Knobs & Conceal. Plate HN10 Horns Top Sash Only Sash Restrictor White x 1 Weatherstrip - White Cill Board groove Cill Drip Groove Timber - Redwood Finger Jointed Laminate Colour - RAL 9016 Traffic white To be site coupled by others No vent Individual Unit Weight 29.836kg			
Line 80	Length: 1045mm	P8W6 Joint Pack	1		
		Item sent loose Timber - Redwood Finger Jointed Laminate 45mm Vertical Joint Pack. Colour - RAL 9016 Traffic white			

NYM NPA  
23 FEB 2015

NYM / 2015 / 4179 / 070

Order ref no. 521598-3

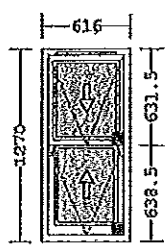
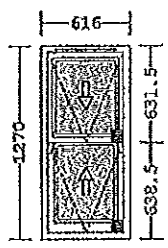
Line	Overall Size	Reference	Qty	Unit Price	Total
Line 81	616 x 1270mm	P8W7A	2		
		<p>Allan Brothers Slide &amp; Tilt 145mm Profile                      Glazing - 6.8mm Lam-18-4mm Tough Soft Coat                      Spacer - Black Swiss V                      Gas - Argon                      Glass Protective Film 2 Sides                      Glazing Beads - Redwood                      Hinge - Top and Bottom Sash S&amp;T PAS24                      White Spiral Tubes and Stoppers                      Sash Lock - White Security Sash Lock                      White hooklift                      White Tilt Latch Knobs &amp; Conceal. Plate                      HN10 Horns Top Sash Only                      Sash Restrictor White x 1                      Trickle Vent - TV90 425HL White (12)                      Weatherstrip - White                      Cill Board groove                      Cill Drip Groove                      Timber - Redwood Finger Jointed Laminate                      Colour - RAL 9016 Traffic white                      To be site coupled by others                      Individual Unit Weight 34.857kg</p>			
Line 82	616 x 1270mm	P8W7B	2		2
		<p>Allan Brothers Slide &amp; Tilt 145mm Profile                      Glazing - 6.8mm Lam-18-4mm Tough Soft Coat                      Spacer - Black Swiss V                      Gas - Argon                      Glass Protective Film 2 Sides                      Glazing Beads - Redwood                      Hinge - Top and Bottom Sash S&amp;T PAS24                      White Spiral Tubes and Stoppers                      Sash Lock - White Security Sash Lock                      White hooklift                      White Tilt Latch Knobs &amp; Conceal. Plate                      HN10 Horns Top Sash Only                      Sash Restrictor White x 1                      Trickle Vent - TV90 425HL White (12)                      Weatherstrip - White                      Cill Board groove                      Cill Drip Groove                      Timber - Redwood Finger Jointed Laminate                      Colour - RAL 9016 Traffic white                      To be site coupled by others                      Individual Unit Weight 34.857kg</p>			
Line 83	Length: 1270mm	P8W7 Joint Pack	2		
		<p>Item sent loose                      Timber - Redwood Finger Jointed Laminate                      45mm Vertical Joint Pack                      Colour - RAL 9016 Traffic white</p>			

NYMNPA  
23 FEB 2015

# Order ref no. 521598-3

KYR / 2015 / 1207 / C.V.C

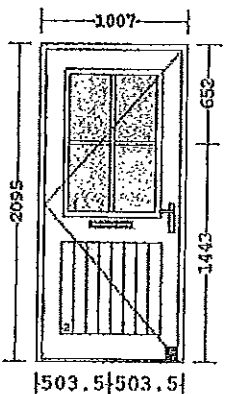
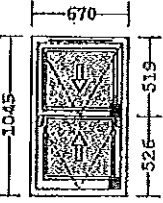
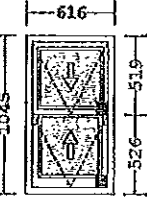
Line	Overall Size	Reference	Qty	Unit Price	Total
Line 84	1007 x 2095mm	P8D7	1		1
		<p>Allan Brothers Scotdoor Dee 92mm Profile                      Glazing - 6.8mm Soft Coat Low E Lam-18-4mm Tough                      Spacer - Black Swiss V                      Gas - Argon                      Glass Protective Film 2 Sides                      Standard pattern to outside and inside.                      Hinge - Zinc Hinges                      LH Open In                      Handle - Polished Chrome ProSecure Handle                      Chrome Letterplate + Chrome Restrictor                      48-38 Nickel Thumb Turn Cylinder                      Grilles - 25mm Bonded Bar + Swiss V Grilles (11.-1)                      Threshold - StormGuard AM3 Silver                      Weatherstrip - White                      Timber - Finger Jointed Laminate Frame                      Spyhole with extension - Chrome                      Security Chain Polished Chrome                      Stippolyte Obscure                      Colour - RAL 9016 Traffic white                      Individual Unit Weight 162.148kg</p>			All rear doors & Plot 9 First Floor Apartment Door
Line 85	670 x 1045mm	P9W1	1		
		<p>Allan Brothers Slide &amp; Tilt 145mm Profile                      Glazing - 4mm-20-4mm Soft Coat Low E                      Spacer - Black Swiss V                      Gas - Argon                      Glass Protective Film 2 Sides                      Glazing Beads - Redwood                      Hinge - Top and Bottom Sash S&amp;T PAS24                      White Spiral Tubes and Stoppers                      Sash Lock - White Security Sash Lock                      White hooklift                      White Tilt Latch Knobs &amp; Conceal. Plate                      HN10 Horns Top Sash Only                      Sash Restrictor White x 1                      Trickle Vent - TV90 425HL White (12)                      Weatherstrip - White                      Cill Board groove                      Cill Drip Groove                      Timber - Redwood Finger Jointed Laminate                      62mm Cill Extension                      Colour - RAL 9016 Traffic white                      Individual Unit Weight 29.152kg</p>			
Line 86	616 x 1045mm	P9W6A	2		
		<p>Allan Brothers Slide &amp; Tilt 145mm Profile                      Glazing - 6.8mm Soft Coat Low E Lam-18-4mm Tough                      Spacer - Black Swiss V                      Gas - Argon                      Glass Protective Film 2 Sides                      Glazing Beads - Redwood                      Hinge - Top and Bottom Sash S&amp;T PAS24                      White Spiral Tubes and Stoppers                      Sash Lock - White Security Sash Lock                      White hooklift                      White Tilt Latch Knobs &amp; Conceal. Plate                      HN10 Horns Top Sash Only                      Sash Restrictor White x 1                      Weatherstrip - White                      Cill Board groove                      Cill Drip Groove                      Timber - Redwood Finger Jointed Laminate                      Stippolyte Obscure                      Colour - RAL 9016 Traffic white                      To be site coupled by others                      No vent                      Individual Unit Weight 29.836kg</p>	<div style="border: 1px solid black; padding: 5px; width: fit-content; margin: 0 auto;">                         NY/MNPA                          23/03/2015                     </div>		

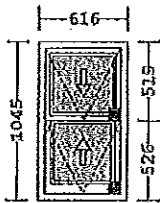
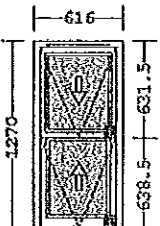
Line	Overall Size	Reference	Qty	Unit Price	T
Line 87	616 x 1045mm	P9W6B	2		£
		Allan Brothers Slide & Tilt 145mm Profile Glazing - 6.8mm Lam-18-4mm Tough Soft Coat Spacer - Black Swiss V Gas - Argon Glass Protective Film 2 Sides Glazing Beads - Redwood Hinge - Top and Bottom Sash S&T PAS24 White Spiral Tubes and Stoppers Sash Lock - White Security Sash Lock White hooklift White Tilt Latch Knobs & Conceal. Plate HN10 Horns Top Sash Only Sash Restrictor White x 1 Weatherstrip - White Cill Board groove Cill Drip Groove Timber - Redwood Finger Jointed Laminate Colour - RAL 9016 Traffic white To be site coupled by others No vent Individual Unit Weight 29.836kg			
Line 88	Length: 1045mm	P9W6 Joint Pack	2		
		Item sent loose Timber - Redwood Finger Jointed Laminate 45mm Vertical Joint Pack Colour - RAL 9016 Traffic white			
Line 89	616 x 1270mm	P9W7A	2		:
		Allan Brothers Slide & Tilt 145mm Profile Glazing - 4mm-20-4mm Soft Coat Low E Spacer - Black Swiss V Gas - Argon Glass Protective Film 2 Sides Glazing Beads - Redwood Hinge - Top and Bottom Sash S&T PAS24 White Spiral Tubes and Stoppers Sash Lock - White Security Sash Lock White hooklift White Tilt Latch Knobs & Conceal. Plate HN10 Horns Top Sash Only Sash Restrictor White x 1 Trickle Vent - TV90 425HL White (12) Weatherstrip - White Cill Board groove Cill Drip Groove Timber - Redwood Finger Jointed Laminate Colour - RAL 9016 Traffic white To be site coupled by others Individual Unit Weight 31.758kg			

NYM/PA  
23 FEB 2015

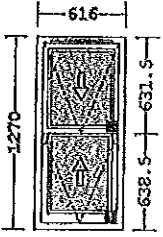
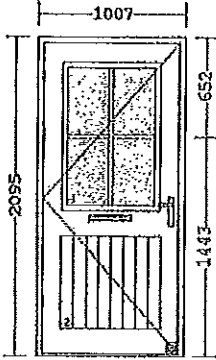
Line	Overall Size	Reference	Qty	Unit Price	Total
Line 90	616 x 1270mm	P9W7B	2		
		Allan Brothers Slide & Tilt 145mm Profile Glazing - 4mm-20-4mm Soft Coat Low E Spacer - Black Swiss V Gas - Argon Glass Protective Film 2 Sides Glazing Beads - Redwood Hinge - Top and Bottom Sash S&T PAS24 White Spiral Tubes and Stoppers Sash Lock - White Security Sash Lock White hooklift White Tilt Latch Knobs & Conceal. Plate HN10 Horns Top Sash Only Sash Restrictor White x 1 Trickle Vent - TV90 425HL White (12) Weatherstrip - White Cill Board groove Cill Drip Groove Timber - Redwood Finger Jointed Laminate Colour - RAL 9016 Traffic white To be site coupled by others Individual Unit Weight 31.758kg			
Line 91	Length: 1270mm	P9W7 Joint Pack	2		
		Item sent loose Timber - Redwood Finger Jointed Laminate 45mm Vertical Joint Pack Colour - RAL 9016 Traffic white			
Line 92	1007 x 2095mm	P9D7	1		
		Allan Brothers Scotdoor Dee 92mm Profile Glazing - 6,8mm Soft Coat Low E Lam-18-4mm Tough Spacer - Black Swiss V Gas - Argon Glass Protective Film 2 Sides Standard pattern to outside and inside Hinge - Zinc Hinges LH Open In Handle - Polished Chrome ProSecure Handle Chrome Letterplate + Chrome Restrictor 48-38 Nickel Thumb Turn Cylinder Grilles - 25mm Bonded Bar + Swiss V Grilles (11.-1) Threshold - StormGuard AM3 Silver Weatherstrip - White Timber - Finger Jointed Laminate frame Spyhole with extension - Chrome Security Chain Polished Chrome Stippolyte Obscure Colour - RAL 9016 Traffic white Individual Unit Weight 162.148kg			All rear doors & Plot 9 First Floor Apartment Door

NYMNP  
 23 Feb 2015

Order ref no. 521598-3

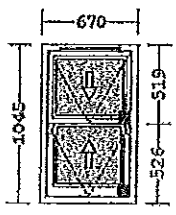
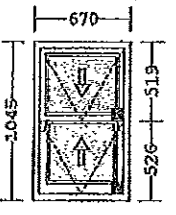
Line	Overall Size	Reference	Qty	Unit Price	
Line 93	670 x 1045mm	P10W1	1		
		Allan Brothers Slide & Tilt 145mm Profile Glazing - 4mm-20-4mm Soft Coat Low E Spacer - Black Swiss V Gas - Argon Glass Protective Film 2 Sides Glazing Beads - Redwood Hinge - Top and Bottom Sash S&T PAS24 White Spiral Tubes and Stoppers Sash Lock - White Security Sash Lock White hooklift White Tilt Latch Knobs & Conceal. Plate HN10 Horns Top Sash Only Sash Restrictor White x 1 Trickle Vent - TV90 42SHL White (12) Weatherstrip - White Cill Board groove Cill Drip Groove Timber - Redwood Finger Jointed Laminate 62mm Cill Extension Colour - RAL 9016 Traffic white Individual Unit Weight 29.152kg			
Line 94	670 x 1045mm	P10W2	1		
		Allan Brothers Slide & Tilt 145mm Profile Glazing - 6.8mm Soft Coat Low E Lam-18-4mm Tough Spacer - Black Swiss V Gas - Argon Glass Protective Film 2 Sides Glazing Beads - Redwood Hinge - Top and Bottom Sash S&T PAS24 White Spiral Tubes and Stoppers Sash Lock - White Security Sash Lock White hooklift White Tilt Latch Knobs & Conceal. Plate HN10 Horns Top Sash Only Sash Restrictor White x 1 Weatherstrip - White Cill Board groove Cill Drip Groove Timber - Redwood Finger Jointed Laminate 62mm Cill Extension Stippolyte Obscure Colour - RAL 9016 Traffic white No vent Individual Unit Weight 31.897kg			

NYMNPA  
23 FEB 2015

# Order ref no. 521598-3

NYM / 2015 / 0123 / 0110

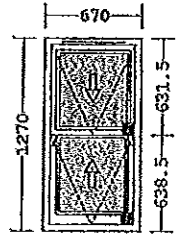
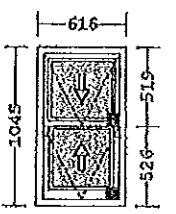
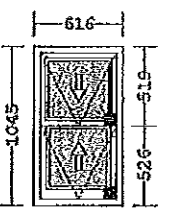
Line	Overall Size	Reference	Qty	Unit Price	Total
Line 95	670 x 1270mm	P10W5	1		
		Allan Brothers Slide & Tilt 145mm Profile Glazing - 6.8mm Lam-18-4mm Tough Soft Coat Spacer - Black Swiss V Gas - Argon Glass Protective Film 2 Sides Glazing Beads - Redwood Hinge - Top and Bottom Sash S&T PAS24 White Spiral Tubes and Stoppers Sash Lock - White Security Sash Lock White hooklift White Tilt Latch Knobs & Conceal. Plate HN10 Horns Top Sash Only Sash Restrictor White x 1 Trickle Vent - TV90 425HL White (12) Weatherstrip - White Cill Board groove Cill Drip Groove Timber - Redwood Finger Jointed Laminate 62mm Cill Extension Colour - RAL 9016 Traffic white Individual Unit Weight 37.247kg			
Line 96	616 x 1045mm	P10W6A	1		
		Allan Brothers Slide & Tilt 145mm Profile Glazing - 6.8mm Lam-18-4mm Tough Soft Coat Spacer - Black Swiss V Gas - Argon Glass Protective Film 2 Sides Glazing Beads - Redwood Hinge - Top and Bottom Sash S&T PAS24 White Spiral Tubes and Stoppers Sash Lock - White Security Sash Lock White hooklift White Tilt Latch Knobs & Conceal. Plate HN20 Horns Top Sash Only Sash Restrictor White x 1 Weatherstrip - White Cill Board groove Cill Drip Groove Timber - Redwood Finger Jointed Laminate Colour - RAL 9016 Traffic white To be site coupled by others No vent Individual Unit Weight 29.836kg			
Line 97	616 x 1045mm	P10W6B	1		
		Allan Brothers Slide & Tilt 145mm Profile Glazing - 6.8mm Lam-18-4mm Tough Soft Coat Spacer - Black Swiss V Gas - Argon Glass Protective Film 2 Sides Glazing Beads - Redwood Hinge - Top and Bottom Sash S&T PAS24 White Spiral Tubes and Stoppers Sash Lock - White Security Sash Lock White hooklift White Tilt Latch Knobs & Conceal. Plate HN10 Horns Top Sash Only Sash Restrictor White x 1 Weatherstrip - White Cill Board groove Cill Drip Groove Timber - Redwood Finger Jointed Laminate Colour - RAL 9016 Traffic white To be site coupled by others No vent Individual Unit Weight 29.836kg			

NYMNP4  
 13/11/2015



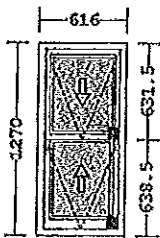
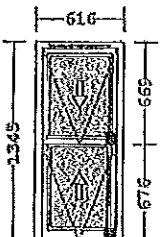

Line	Overall Size	Reference	Qty	Unit Price	Total
Line 101	616 x 1270mm	P10W7B	4		
		Allan Brothers Slide & Tilt 145mm Profile Glazing - 6.8mm Lam-18-4mm Tough Soft Coat Spacer - Black Swiss V Gas - Argon Glass Protective Film 2 Sides Glazing Beads - Redwood Hinge - Top and Bottom Sash S&T PAS24 White Spiral Tubes and Stoppers Sash Lock - White Security Sash Lock White hooklift White Tilt Latch Knobs & Conceal. Plate HN10 Horns Top Sash Only Sash Restrictor White x 1 Weatherstrip - White Cill Board groove Cill Drip Groove Timber - Redwood Finger Jointed Laminate Colour - RAL 9016 Traffic white To be site coupled by others No vent Individual Unit Weight 34.857kg			
Line 102	Length: 1270mm	P10W7 Joint Pack	4		
		Item sent loose Timber - Redwood Finger Jointed Laminate 45mm Vertical Joint Pack Colour - RAL 9016 Traffic white			
Line 103	616 x 1345mm	P10W9A	3		
		Allan Brothers Slide & Tilt 145mm Profile Glazing - 6.8mm Lam-18-4mm Tough Soft Coat Spacer - Black Swiss V Gas - Argon Glass Protective Film 2 Sides Glazing Beads - Redwood Hinge - Top and Bottom Sash S&T PAS24 White Spiral Tubes and Stoppers Sash Lock - White Security Sash Lock White hooklift White Tilt Latch Knobs & Conceal. Plate HN10 Horns Top Sash Only Sash Restrictor White x 1 Trickle Vent - TV90 425HL White (12) Weatherstrip - White Cill Board groove Cill Drip Groove Timber - Redwood Finger Jointed Laminate Colour - RAL 9016 Traffic white To be site coupled by others Individual Unit Weight 36.531kg			

NYMNPA  
 23 APR 2015

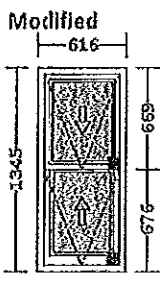
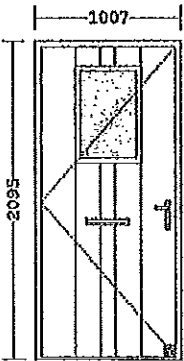
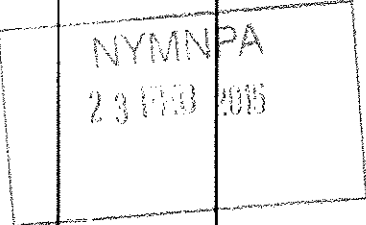
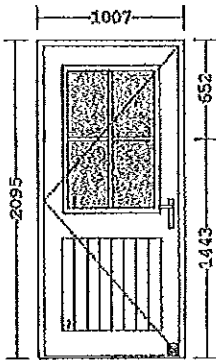
Line	Overall Size	Reference	Qty	Unit Price	Total
Line 104	616 x 1345mm	P10W9B	3		
		Allan Brothers Slide & Tilt 145mm Profile Glazing - 6.8mm Lam-18-4mm Tough Soft Coat Spacer - Black Swiss V Gas - Argon Glass Protective Film 2 Sides Glazing Beads - Redwood Hinge - Top and Bottom Sash S&T PAS24 White Spiral Tubes and Stoppers Sash Lock - White Security Sash Lock White hooklift White Tilt Latch Knobs & Conceal. Plate HN10 Horns Top Sash Only Sash Restrictor White x 1 Weatherstrip - White Cill Board groove Cill Drip Groove Timber - Redwood Finger Jointed Laminate Colour - RAL 9016 Traffic white To be site coupled by others Individual Unit Weight 36.531kg			
Line 105	Length: 1345mm	P10W9 Joint Pack	3		
		Item sent loose Timber - Redwood Finger Jointed Laminate 45mm Vertical Joint Pack Colour - RAL 9016 Traffic white			
Line 106	1007 x 2095mm	P10D1	1		
		Allan Brothers Scotdoor Clyde 92mm Profile Glazing - 6.8mm Soft Coat Low E Lam-18-4mm Tough Spacer - Black Swiss V Gas - Argon Glass Protective Film 2 Sides Standard pattern to outside and inside Hinge - Zinc Hinges LH Open In Handle - Polished Chrome ProSecure Handle Chrome Letterplate + Chrome Restrictor 48-38 Nickel Thumb Turn Cylinder Threshold - StormGuard AM3 Silver Weatherstrip - White Timber - Finger Jointed Laminate Frame Spyhole with extension - Chrome Security Chain Polished Chrome Stippolyte Obscure Colour - RAL 9016 Traffic white Individual Unit Weight 150.201kg			Plots 1,2, 5, 10 Front Door
					
Line 107	1007 x 2095mm	P10D7	1		
		Allan Brothers Scotdoor Dee 92mm Profile Glazing - 6.8mm Lam-18-4mm Tough Soft Coat Spacer - Black Swiss V Gas - Argon Glass Protective Film 2 Sides Standard pattern to outside and inside Hinge - Zinc Hinges LH Open In Handle - Polished Chrome ProSecure Handle 48-38 Nickel Cylinder Grilles - 25mm Bonded Bar + Swiss V Grilles (11.-1) Threshold - StormGuard AM3 Silver Weatherstrip - White Timber - Finger Jointed Laminate Frame Colour - RAL 9016 Traffic white Individual Unit Weight 162.148kg			All rear doors & Plot 9 First Floor Apartment Door

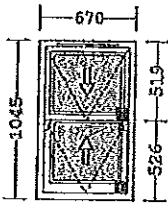
Line	Overall Size	Reference	Qty	Unit Price	Total
Line 108	Length: 1350mm	1350mm Loose Cills	27		
		Item sent loose Timber - Redwood Finger Jointed Laminate 62mm Cill Extension Colour - RAL 9016 Traffic white			
Line 109	Length: 1700mm	1700mm Loose Cills	7		
		Item sent loose Timber - Redwood Finger Jointed Laminate 62mm Cill Extension Colour - RAL 9016 Traffic white			
Line 110	Length: 1045mm	W11 Cover Facings	4		
		Item sent loose Timber - Redwood Finger Jointed Laminate DPM119 Internal Cover Facing DPR119 External Cover Facing Colour - RAL 9016 Traffic white			
Line 111	670 x 1045mm	P10W1 (SBD)	1		
		Allan Brothers Slide & Tilt 145mm Profile Glazing - 6.8mm Lam-18-4mm Tough Soft Coat Spacer - Black Swiss V Gas - Argon Glass Protective Film 2 Sides Glazing Beads - Redwood Hinge - Top and Bottom Sash S&T PAS2A White Spiral Tubes and Stoppers Sash Lock - White Security Sash Lock White hooklift White Tilt Latch Knobs & Conceal. Plate HN10 Horns Top Sash Only Sash Restrictor White x 1 Trickle Vent - TV90 425HL White (12) Weatherstrip - White Cill Board groove Cill Drip Groove Timber - Redwood Finger Jointed Laminate 62mm Cill Extension Colour - RAL 9016 Traffic white Individual Unit Weight 31.897kg			

185

Total Exc. VAT.

Delivery

Total + Delivery Exc. VAT.

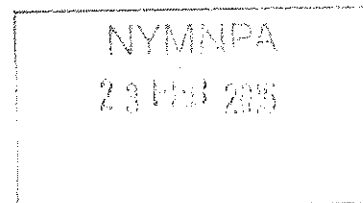

The general contractor is responsible for the verification all dimensions on site and the architect is to be informed of any discrepancy.  
 The status of information contained in a computer copy of this drawing shall be limited to that conveyed by the paper copy.

**Design Criteria**  
 Site to comply with the following design criteria subject to confirmation of the form of construction and assessment by an external accredited assessor.  
 ■ Design and Quality Standards: (G)  
 ■ General needs.  
 ■ Code for Sustainable Homes Level: (3)  
 □ BREEM Rating: (NA)  
 ■ Lifetime Homes: (Yes)  
 ■ Building For Life Minimum Score: (10)  
 ■ Rural Adjustment  
 ■ Secured by Design: (B)  
 Buildings Only  
**Revisions:**  
 Rev A 31.07.2014 TS/DPG  
 Drawing status updated to construction.  
 Rev B 03.11.2014 TS/DPG  
 W12 amended to suit window detailed at planning.

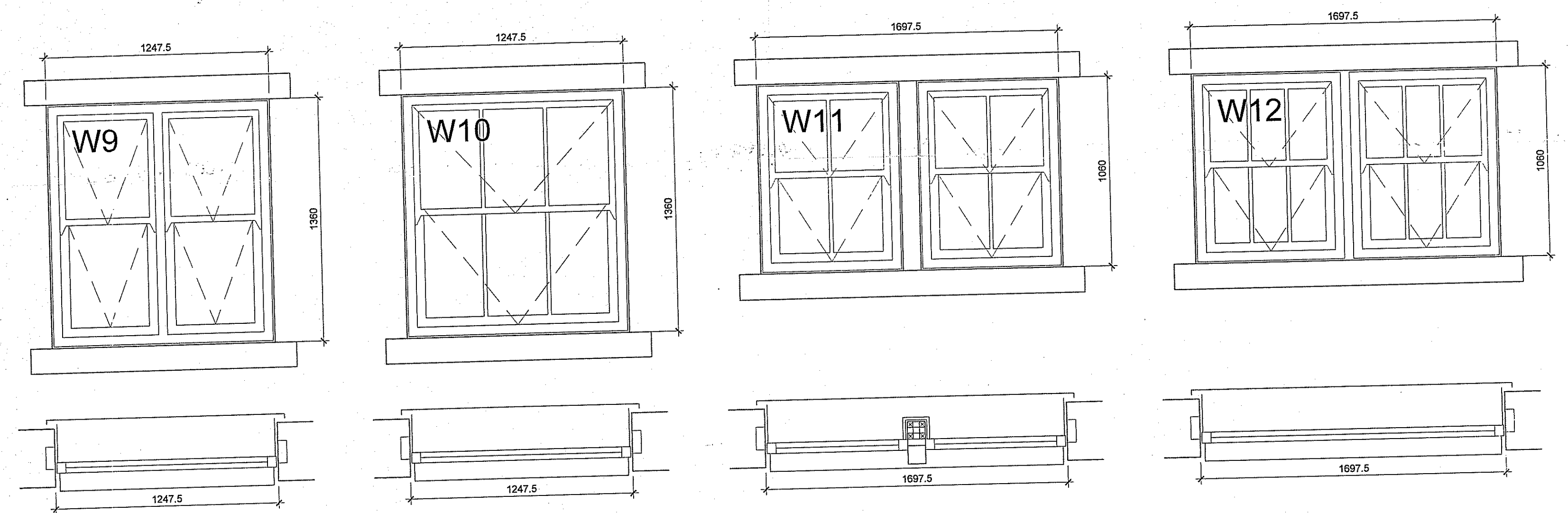
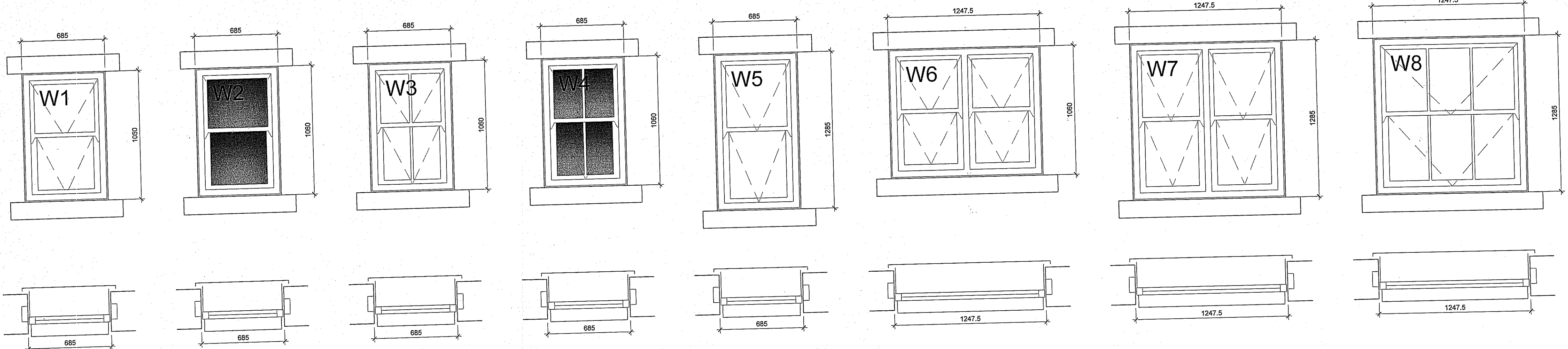
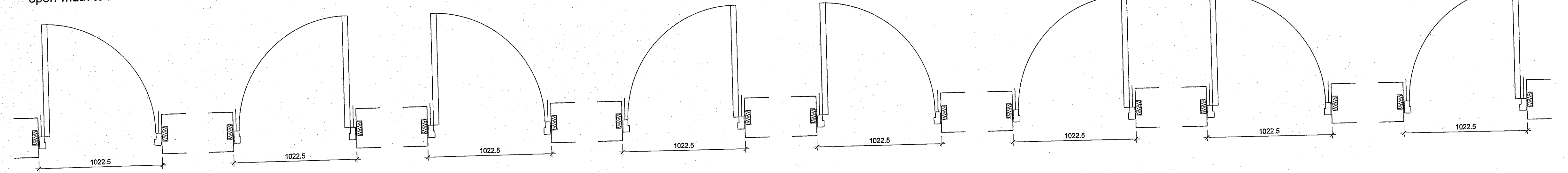
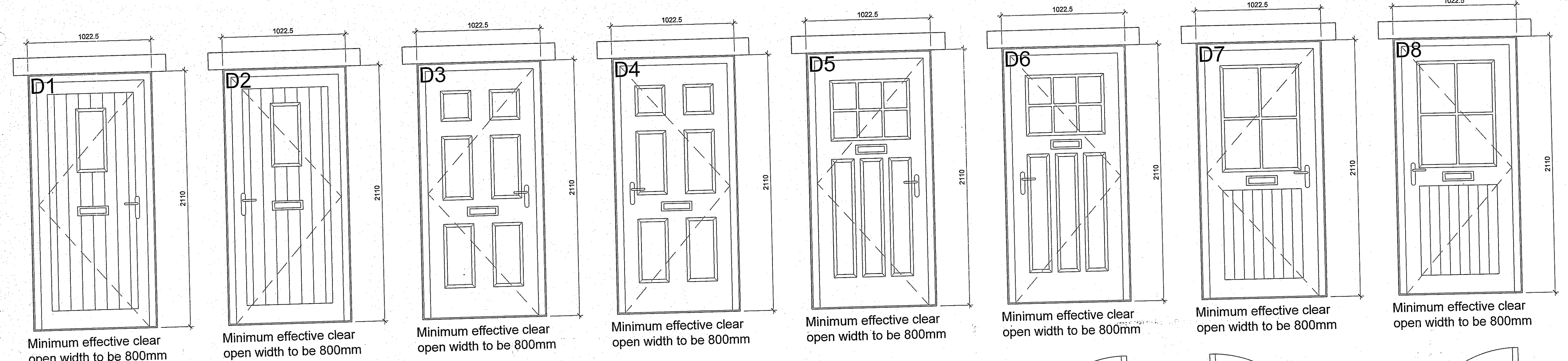

- Notes**
- Windows to be timber sash look-a-like slide and tilt double glazed units to comply with Approved Document L1A. Windows to comply with Approved Document L1A with an average U value of at least 1.5 W/m<sup>2</sup>k.
  - Escape windows where required are to have an unobstructed opening area of 0.33m<sup>2</sup> and at least 450mm high x 450mm wide and not more than 1100mm from floor level as Part B1, 2.1a. All top hung windows to have hold open mechanism so not to hinder escape.
  - External doors to have an average U value of at least 1.5 W/m<sup>2</sup>k and comply with Secured by Design recommendations
  - Safety glazing in accordance with BS 6202:1981 should be used in the following locations: a) between FFL and 800mm. b) between FFL and 1500mm in a door or side panel, within 300mm either edge of the door. c) 'Secured by Design' require laminated glazing in external doors and side lights for physical security (glazing marked in lower corner).
  - Windows to be fitted with opening restrictors and easy clean hinges for safety and cleaning.
  - All windows above ground floor which are at low level or full height to be fixed for containment.
  - Background Ventilation - Adjustable/ controllable ventilation openings (trickle vents) having a minimum equivalent area of 2500mm<sup>2</sup> fitted in each room, except wet rooms, from which air is extracted. Locate minimum 1.7m above floor level.
  - Purge ventilation - Openable windows to the following rooms stated as follows: a) Habitable Rooms: One or more opening windows with total area of at least 1/20th of the floor area. b) Wet Rooms: One or more opening window (no minimum size).
  - All windows and doors to comply with Secured by Design requirements.
- Note:- Drawing to be read in conjunction with the general Arrangement plans and elevations. Refer to elevations for the location of Obscure Glass.  
 F - Fixed Light

N/A  
 23 FEB 2015

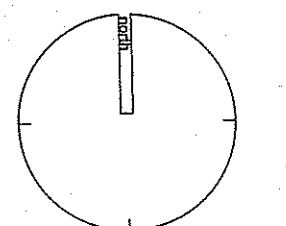

<b>home group</b>		
Drawing Status	<input type="checkbox"/> preliminary	<input type="checkbox"/> planning
	<input type="checkbox"/> information	<input type="checkbox"/> tender
	<input type="checkbox"/> comment	<input checked="" type="checkbox"/> construction
	<input type="checkbox"/> approval	<input type="checkbox"/> record/as built
Scale	1:20 @ a1	
Date	July 2014	
Drawn/Checked	TS/DPG	
Dwg.No	1700.63.2600B	

**Window & Door Components**  
 High Street, Egton  
 Home Group

